



2014

WATER GARDENING
PRODUCT CATALOG



NEW FOR 2014



NEW SOL LIGHTING OPTIONS, SEE PAGES 56-59

When darkness falls, set your landscape aglow with new SOL Lighting options, above and below the waterline! Nothing creates ambiance in the garden like lighting, and Atlantic has just what you need. Solid brass architectural grade fixtures house ultra-efficient and long-lasting LEDs, in either remote controlled Color Changing or Warm White lamps, all cool to the touch, fully waterproof and available in multi-fixture Kits with a variety of power and cabling options – Atlantic’s newest line was a year in the making, and well worth the wait!

2014 also heralds a new name and new look for our Classic water garden line, rechristened Waterscapes by Atlantic. See the insert catalog for more information about the tried-and-true water feature products that started it all.

TABLE OF CONTENTS:

FORMAL SPILLWAYS

Color Changing Colorfalls	6-7
Classic Colorfalls	8-9
Stainless Steel Scuppers & Accessories	10-11
Basin Kits & Accessories	12-13

WATER GARDEN

Skimmers	16-17
FilterFalls	18-19
Pond Kits	20-21

ACCESSORIES

Rock Lids	23
Skimmer Accessories	24
FilterFalls Accessories	25

POND-FREE

FastFalls	28-29
Pump Vaults	30-31
Eco-Blox	32
Pond-free Kits	33

FOUNTAIN

Eco-Rise	36
Fountain Basins	37
Fountain Kits	38
Toppers	39

PUMPS

Comprehensive Pump Chart	41
Mag Drive Pumps	42
Fountain Heads	43
Fountain Pumps	44
TidalWave2 Pumps	45
SH-Series Pumps	46
PAF Series Pumps	47
A-Series Pumps	48
L-Series Pumps & Pump Protector	49

INSTALLATION

Triton Check Valve & AWGCV30	51
Installation Products	52-53

LIGHTING

SOL Lighting	55
SOL LED Lighting	56-57
SOL Color Changing	58-59

MAINTENANCE

Triton Ionizer	61
Biocuda Treatments	62-63
Biocuda Fish Food	64
Typhoon Air Pumps	65
Pond & Garden Protector	66
Ultra Pond Nets	67

RAIN HARVESTING

Clean Rain Ultra	69
Pump Vault	70
Pumps	71
Accessories	72
Kits	73

TRAINING & RETAIL POP

Atlantic Water Gardens University	74
POP Material	75



FORMAL SPILLWAYS

When the effect required is classic and refined rather than natural, our Formal Spillways fit the bill! Whether Colorfalls or Scupper, gleaming Stainless Steel or translucent Acrylic, reflective or radiant, our Spillways add elegance to any landscape and style to any interior. Lit from within or glowing from below, all of our Formal Spillways are designed to carry the beauty of water deep into the evening.

THE COMPLETE FORMAL SPILLWAY SYSTEM

The Atlantic Formal Spillway System is what sets us apart from the rest. Not just an attractive accent, our Formal Spillways are the centerpiece of a well-designed outdoor living installation.

Formal Spillway System features:

- Basin dimensions that work with popular retaining walls and paving stones for easy installation with minimal cutting.
- Built-in plumbing recesses that keep all the plumbing within the dimensions of the basin, for clean lines without saw cuts.
- Matala filter mats that clean the water, diffuse turbulence and eliminate bubbles, allowing more light through the falls.
- Complete Basin Kits that work interchangeably with all Formal Spillway styles, providing you with everything you need to install a complete system.
- Three distinct spillway styles: Color Changing Colorfalls, original Colorfalls, and Stainless Steel Scuppers that offer different looks for varying tastes.
- A new body design for the Color Changing Colorfalls that offers complete access for easy maintenance, multiple plumbing and color options and the unmatched capacity to simply thread together any number of units for waterfalls of unlimited width!

Atlantic's Formal Spillway System is not the best by accident;

it's the best by design.

COLORFALLS INSTALLATION:

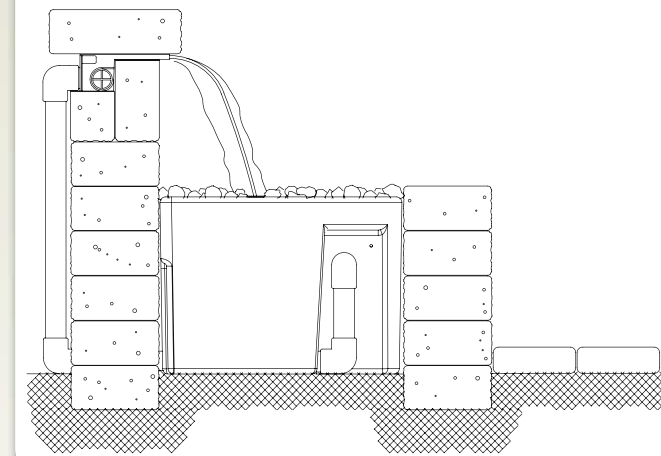

BASIN KIT INSTALLATION

Colorfalls

COLOR CHANGING

Atlantic's Color Changing Colorfalls add a whole new dimension to Formal Spillways. The modular body style offers easier maintenance, with a removable back for easy access and side plumbing ports. A more generous weir opening resists clogging and creates a thicker, fuller sheer for extra color and less wind deflection. The innovative modular design with easy to install threaded couplings makes connecting any number of falls together a snap! The LED light bar offers 48 vibrant color options and 16 patterns via remote control.



MASTER CONTROLLER

Whether you want to create a single, seamless waterfall up to 15 feet wide, or to synchronize multiple Color Changing Colorfalls, the CCCM05 Master Controller makes linking them simple. Just plug each LED light bar into the five-way splitter and synchronize as many as five different Color Changing Colorfalls with a single transformer and a single remote!

MODELS :

Model: CC06
 Description: 6" Color Changing Colorfalls
 Flow Rate: 600 gph
 Input Voltage: 12 volt DC
 Watts: 3.5 Variable
 Inlet: 1½" FIPT
 Dimensions: 6"W x 8"D x 3½"H

Model: CC12
 Description: 12" Color Changing Colorfalls
 Flow Rate: 1,200 gph
 Input Voltage: 12 volt DC
 Watts: 7 Variable
 Inlet: 1½" FIPT
 Dimensions: 12"W x 8"D x 3½"H

Model: CC24
 Description: 24" Color Changing Colorfalls
 Flow Rate: 2,400 gph
 Input Voltage: 12 volt DC
 Watts: 14 Variable
 Inlet: 1½" FIPT
 Dimensions: 24"W x 8"D x 3½"H

Model: CC36
 Description: 36" Color Changing Colorfalls
 Flow Rate: 3,600 gph
 Input Voltage: 12 volt DC
 Watts: 20 Variable
 Inlet: 1½" FIPT
 Dimensions: 36"W x 8"D x 3½"H

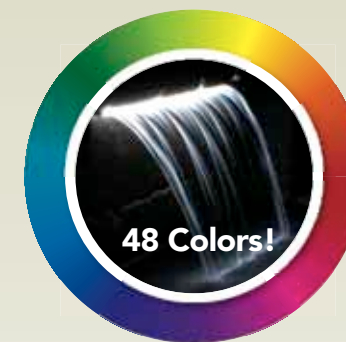
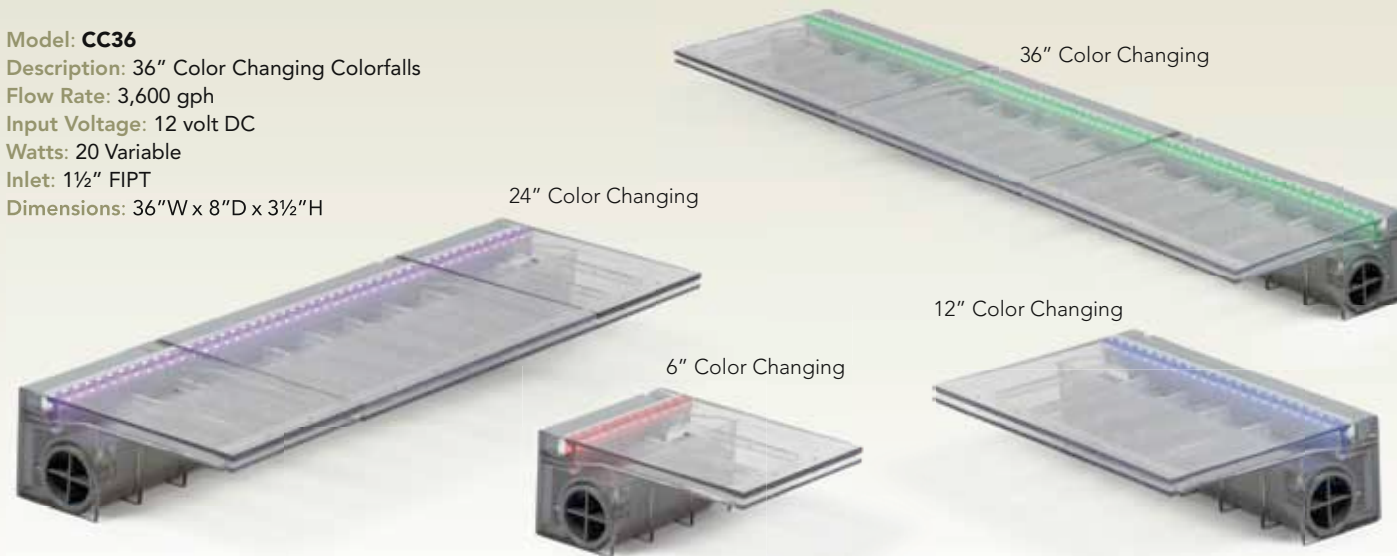

Model: CCCM05
 Description: Master Control Module for Color Changing Colorfalls
 Input Voltage: 120 Volt AC
 Output Voltage: 12 Volt AC / 80 watts
 Dimensions: 6"L x 3¼"D x 3¼"H
 Includes: 80 watt transformer and 5-way splitter
 Warranty: 1 year

COLOR CHANGING FEATURES:

- 5" lip extension
- 12 volt single control module with weather resistant outdoor enclosure & remote control
- 20' power cord
- 1-year warranty

Each Color Changing Colorfalls includes a **Single Control Module & Remote Control**

Input Voltage: 12 Volt AC
 Output Voltage: 12 Volt DC / 4-wire



NOT COMPATIBLE WITH SOL COLOR CHANGING LIGHTING

COLOR CHANGING COLORFALLS FEATURES:

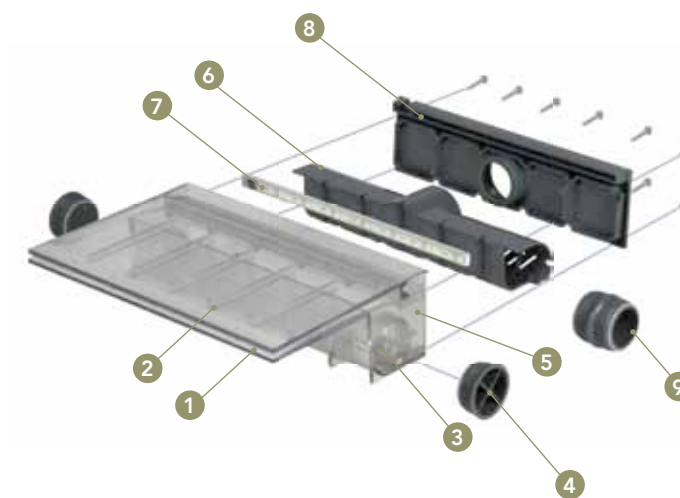

1. Larger weir opening produces a thicker sheer, less splash, more color and less chance of clogging
2. Redesigned supports eliminate splitting of the water sheer and increase load capacity
3. 1½" FIPT side and back plumbing options for maximum versatility
4. Includes (2) 1½" plugs for unused plumbing inlets
5. Self-draining body for easy winterization
6. Removable baffle for easy cleaning and servicing
7. Color Changing LED light bar that is accessible from the rear of the unit
8. Removable back plate provides unparalleled access to the interior and light bar for routine maintenance
9. Includes threaded adapter for connecting multiple Color Changing Colorfalls

PATENT PENDING

Colorfalls

LIGHTED FALLS

Atlantic's original Colorfalls brought the Formal Spillway to the Backyard Oasis, and they're still the perfect fit for all your vertical wall applications. Whether your wall is brick or block, natural stone or ceramic tile, you can add the beauty of shimmering brilliance in red, white or blue to your water feature, day and night!

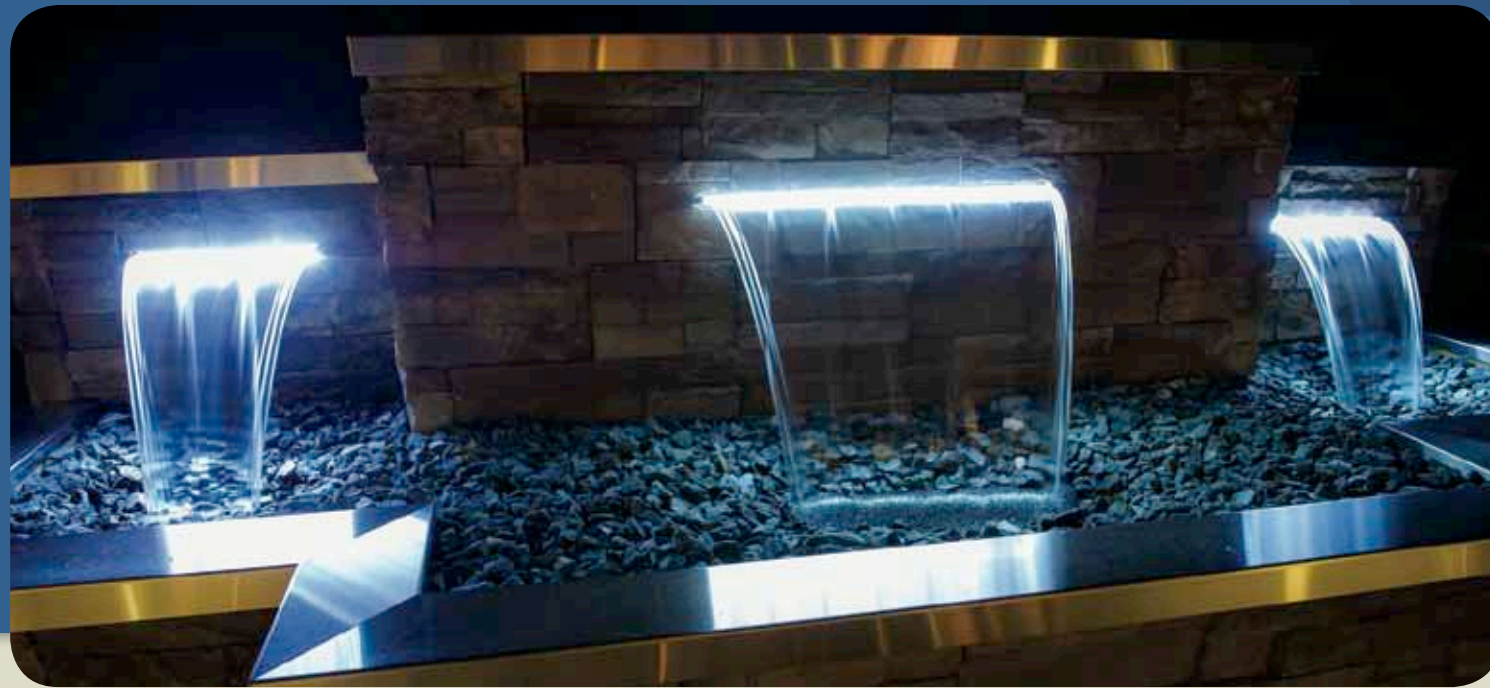

Colorfalls COME IN
4 VIBRANT COLORS:



MODELS :

Model: CF12B Ice Blue
CF12R Fire Red
CF12W Crystal White
CF12SW SOL White

Description: 12" Colorfalls
Flow Rate: 1,000 gph
Watts: 3
Inlet: 1/4" FIPT
Dimensions: 12"W x 8"D x 3 1/2"H

Model: CF24B Ice Blue
CF24R Fire Red
CF24W Crystal White
CF24SW SOL White

Description: 24" Colorfalls
Flow Rate: 2,000 gph
Watts: 6
Inlet: 1/4" FIPT
Dimensions: 24"W x 8"D x 3 1/2"H

Model: CF36B Ice Blue
CF36R Fire Red
CF36W Crystal White
CF36SW SOL White

Description: 36" Colorfalls
Flow Rate: 3,000 gph
Watts: 9
Inlet: 1/4" FIPT
Dimensions: 36"W x 8"D x 3 1/2"H

COLORFALLS FEATURES:

- 5" lip extension
- 12 volt outdoor transformer
- 30' power cord
- 1-year warranty



STAINLESS STEEL SCUPPERS

Atlantic's newest entry to the Formal Spillways category, our Stainless Steel Scuppers bring a polished, gleaming dimension to our spillway line. Constructed of durable 304 stainless steel and available in the same sizes as our popular Colorfalls, these sleek modern Scuppers put a sharp, fresh shine on your formal water feature project.



MODELS :

Model: SS12
Description: 12" Stainless Steel Scupper
Flow Rate: 1,200 gph
Inlet: 1½" FIPT
Dimensions: 12"W x 8½"D x 4"H

Model: SS24
Description: 24" Stainless Steel Scupper
Flow Rate: 2,400 gph
Inlet: 1½" FIPT
Dimensions: 24"W x 8½"D x 4"H

Model: SS36
Description: 36" Stainless Steel Scupper
Flow Rate: 3,600 gph
Inlet: 1½" FIPT
Dimensions: 36"W x 8½"D x 4"H



SCUPPER FEATURES:

- 5" lip extension
- Fully welded enclosure
- 304 Stainless steel
- 1-year warranty



STAINLESS STEEL SPLASH RINGS

Our latest spillway enhancement, Atlantic's Splash Rings keep stones in place and splash at bay with style. As effective as our Splash Mats but with the appeal of steel, the 304 stainless banded mesh ovals are as versatile as they are attractive. Set mesh up as shown to amplify the sound of the waterfall or for a different effect, flip the Splash Ring over and the thin sidewall keeps stones in place almost invisibly. Place an LED Ring Light under the mesh to illuminate the falls from below.

MODELS :



Model: CFSR12
Description: Stainless Steel Splash Ring
For Use With: CFBASIN12
Dimensions: 16"W x 8"D x 1½"H

Model: CFSR24
Description: Stainless Steel Splash Ring
For Use With: CFBASIN24
Dimensions: 28"W x 8"D x 1½"H

Model: CFSR36
Description: Stainless Steel Splash Ring
For Use With: CFBASIN36
Dimensions: 40"W x 8"D x 1½"H



Add a SOL Light Ring for an elegant nighttime effect!

See Light Rings on pages 56 and 58.

ACCESSORY PRODUCT

8oz. Biocuda Colorfalls & Fountain Treatment

Model: CFFT800

- Clears water fast!
- For use with Formal Spillways and all Pond-free fountains



FORMAL SPILLWAY BASIN KITS

Atlantic Basin Kits are designed to fit all our formal spillways perfectly. Whether you're adding the shimmering nighttime enchantment of a Classic or Color Changing Colorfalls or the elegant touch of class of the Stainless Steel Scupper, our Basin Kits provide everything you need to complete the installation, from the reservoir to the plumbing to the pump, with double filtration, tubing, fittings, anti-splash mat and even an Automatic Fill Valve.



BASINS & ACCESSORIES

Atlantic's spillway basins feature a pre-filtered pump chamber, one piece construction and built-in plumbing channels to create a perfect reservoir for formal spillway projects. Add an optional splash mat to reduce splash, conserve water and ensure your pump remains submersed at all times.

MODELS :



12" BASIN KIT

Model: **CFBASINKIT12**
 Description: Complete Basin Kit
 For Use With: All 12" Spillways
 Dimension: 20"W x 20"D x 16"H
 Includes: CFBASIN12 and TW1200 pump



24" BASIN KIT

Model: **CFBASINKIT24**
 Description: Complete Basin Kit
 For Use With: All 24" Spillways
 Dimension: 44"W x 22"D x 16"H
 Includes: CFBASIN24 and TW2400 pump



36" BASIN KIT

Model: **CFBASINKIT36**
 Description: Complete Basin Kit
 For Use With: All 36" Spillways
 Dimension: 56"W x 24"D x 16"H
 Includes: CFBASIN36 and TW3700 pump

Basin Kits Include:

- Colorfalls Basin & TW2 Pump
- 1½" x 10' Flexible PVC Pipe
- Splash Mat
- AF1000 Auto Fill
- Complete Installation Kit including pump discharge, flow valve, spray glue and thread sealant



COLORFALLS BASIN FEATURES:

- Pre-filtered pump chamber
- One-piece construction
- Built-in plumbing channels
- Can be installed above or below grade
- For use with Colorfalls and Stainless Steel Scuppers

MODELS :



Model: **CFBASIN12**
 Dimension: 20"W x 20"D x 16"H
 Capacity: 18 Gallons
 Filtering: Matala Filter Mat



Model: **CFBASIN24**
 Dimensions: 44"W x 22"D x 16"H
 Capacity: 33 Gallons
 Filtering: Matala Filter Mat



Model: **CFBASIN36**
 Dimension: 56"W x 24"D x 16"H
 Capacity: 42 Gallons
 Filtering: Matala Filter Mat



Model: **CFSPMA12**
 Description: Splash Mat
 Dimensions: 17"L x 17"W
 For Use With: CFBASIN12



Model: **CFSPMA24**
 Description: Splash Mat
 Dimensions: 41"L x 19"W
 For Use With: CFBASIN24

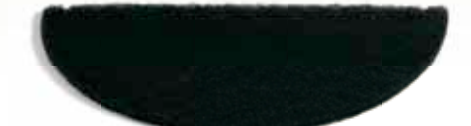

Model: **CFSPMA24**
 Description: Splash Mat
 Dimension: 53"L x 21"W
 For Use With: CFBASIN36

WATER GARDEN

Atlantic has the equipment you want for all your water gardening needs. With fish-friendly Skimmers and FilterFalls that enhance biological activity in sturdy, long-lasting housings with high quality components designed to lower maintenance costs, our Water Garden System provides the peace of mind you need.

THE COMPLETE WATER GARDEN SYSTEM



Atlantic's Water Garden System offers a complete solution for every pondbuilder, with full-featured Skimmers that allow for every plumbing and prefilter preference, and FilterFalls that can be upgraded as ponds mature and organic loads increase. Whether you prefer to individually select the custom accessories for your Water Garden System, or to simply choose a Pond Kit that comes with all the equipment, liner and plumbing you'll need to complete the project without having to run to the hardware store, Atlantic has it all!

Water Garden System Features:

- Heavy-walled rotomolded polypropylene construction for crush-proof installations and warp-free longevity
- Stainless steel hardware, frames and brushes to control rusting and corrosion for the lifetime of the product
- Lifetime warranty on all Skimmers, FilterFalls, Pump Vaults, and FastFalls housings

Whether your pond project features lively goldfish, gorgeous koi or magnificent water lilies, our Water Garden System provides everything you'll need for years of trouble-free service.

TYPICAL POND INSTALLATION

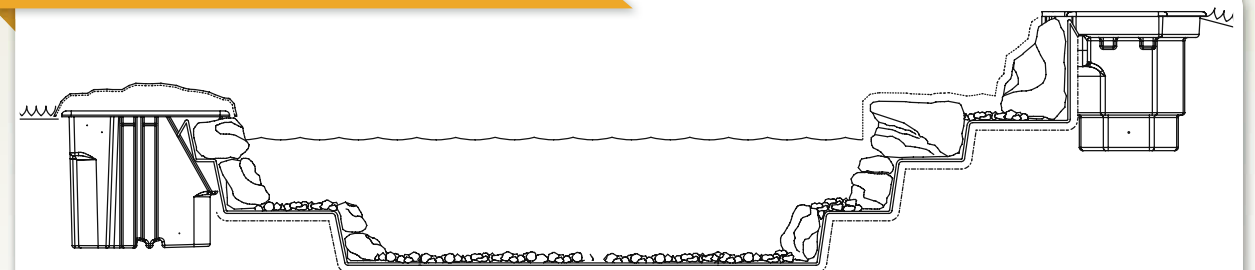

SKIMMERS



Atlantic's Pond Skimmers offer just what you need for all of your pond projects. With ample pre-filtration options, auto fill capacity, complete freedom in plumbing location, multiple pump capability and remarkable strength and rigidity, these versatile components allow for every style and preference!

Oasis SERIES MODEL:



Model: **PS3900**
 Weir Width: 6"
 Internal Water Depth: 14½"
 Dimensions: 17¾"W x 19½"D x 19½"H
 Pump Flow Range: 1,000 - 3,900 gph
 Sq. Ft. Rating: 200
 Filtering: Net, Matala mat
 Match to FilterFalls: BF1600

OASIS SKIMMER FEATURES:

1. Sturdy removable lid supports natural rock camouflage and foot traffic
2. Support bar for added strength
3. Stainless steel-framed trap net and Matala filter mat provide mechanical filtration
4. High density polyethylene enclosure
5. Rolled upper rim provides clean lines and incredible strength
6. Pump discharge step fittings for 1½" & 2" pipe provided on both sides of the skimmer
7. Super Flow weir door for maximum surface cleaning
8. Labeled drill points for the installation of Auto Fill and overflow (not shown)



Model PS3900 shown

BioBahama PRO SERIES MODELS:



Model: **PS4600**
 Weir Width: 6"
 Internal Water Depth: 15½"
 Dimensions: 19½"W x 26"D x 22"H
 Max Pump Flow: 4,000 gph
 Sq. Ft. Rating: 400
 Filtering: Net, Brush panel
 Match to FilterFalls: BF1900



Model: **PS7000**
 Weir Width: 9"
 Internal Water Depth: 17½"
 Dimensions: 25"W x 30"D x 24"H
 Max Pump Flow: 7,000 gph
 Sq. Ft. Rating: 900
 Filtering: Net, Brush panel
 Match to FilterFalls: BF2600



Model: **PS15000**
 Weir Width: 14"
 Internal Water Depth: 24½"
 Dimensions: 28"W x 33"D x 31"H
 Max Pump Flow: 15,000 gph
 Sq. Ft. Rating: 1400
 Filtering: Net, Brush panel
 Match to FilterFalls: BF3800



Model: **PS3000**
 Weir Width: 6"
 Dimensions: 13"W x 13"D x 25"H
 Pump Flow Range: 1,000 - 3,000 gph
 Filtering: Net
 Application: Satellite Skimmer - Drawing and cleaning water from hard-to-reach areas of a pond, the Satellite Skimmer is used in combination with (and plumbs into) the main pond skimmer. PS3000 installs inside or outside the pond.
 Use with Skimmer: PS7000 / PS15000

PRO SERIES SKIMMER FEATURES:

1. Sturdy removable top lid supports natural rock camouflage and foot traffic
2. Heavy-duty brush panel provides maximum surface area for mechanical filtration
3. Heavy-duty stainless steel framed trap net for catching large debris
4. Rolled upper rim provides clean lines and great strength
5. Super Flow weir door for maximum surface cleaning
6. High-density polyethylene shell for the ultimate in durability



Model PS7000 shown

RECOMMENDED PRODUCTS



Triton Check Valve, page 51



Rock Lid, page 23

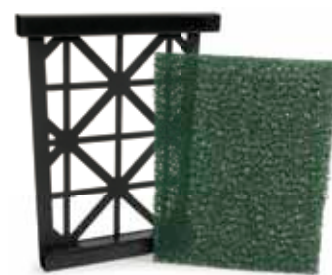

Matala Mat Kits, page 25

FILTERFALLS



Atlantic's FilterFalls are not only the perfect complement to our Skimmers, they offer performance and upgradeable filtration options that every pondbuilder will appreciate. Massively strong, with capacious interiors that accept up to six Matala mats and a variety of available biomed, these solid workhorses provide the ultimate filter solution from newly installed to even the most heavily stocked ponds!

Oasis SERIES MODEL:



Model: **BF1600**
 Waterfall Width: 16" Spillway
 Dimensions: 21½"W x 19½"D x 17¾"H
 Pump Flow Range: 1,000 - 3,900 gph
 Bulkhead: 1½"
 Pond Volume: up to 1,250 gal
 Match to Skimmer: PS3900

OASIS FILTERFALLS FEATURES:

1. Sturdy top grate and support bar allow natural rock camouflage
2. Media bag for additional biological filtration
3. Dual Bio-Tech filter mats for biological filtration
4. Sturdy bottom grate supports filter media
5. Rolled upper rim provides clean lines and incredible strength
6. One-piece liner attachment flange
7. Heavy-duty 1½" FIPT bulkhead



Model BF1600 shown

BioBahama PRO SERIES MODELS:



Model: **BF1900**
 Waterfall Width: 19" Spillway
 Dimensions: 28"W x 25"D x 21½"H
 Pump Flow Range: 2,500 - 4,000 gph
 Bulkhead: 2"
 Pond Volume: up to 2,000 gal
 Match to Skimmer: PS4600



Model: **BF2600**
 Waterfall Width: 26" Spillway
 Dimensions: 34½"W x 25"D x 23"H
 Pump Flow Range: 4,000 - 6,000 gph
 Bulkhead: 2"
 Pond Volume: up to 4,000 gal
 Match to Skimmer: PS7000



Model: **BF3800**
 Waterfall Width: 38" Spillway
 Dimensions: 46½"W x 30"D x 23"H
 Pump Flow Range: 6,000 - 8,000 gph
 Bulkhead: 3"
 Pond Volume: up to 8,000 gal
 Match to Skimmer: PS15000

PRO SERIES FASTFALLS FEATURES:

1. Heavy-duty removable top grate supports rock camouflage
2. Support bars add stability and reinforce top grate
3. Media Bag for Bio-Tech media / Bio-Balls (sold separately) provide maximum surface area for beneficial bacteria
4. Dual Bio-Tech filter mats for biological filtration
5. Sturdy bottom grate supports filter media
6. Rolled upper rim provides clean lines and incredible strength
7. 2" or 3" heavy-duty FIPT bulkhead for high flow rates
8. Bottom chamber accepts bulkheads on all sides while bottom cones reduce surface area for back flushing
9. One-piece liner flange allows easy, leak-free attachment of FilterFalls to pond liner
10. Solid lip and molded inserts ensure a watertight liner attachment every time

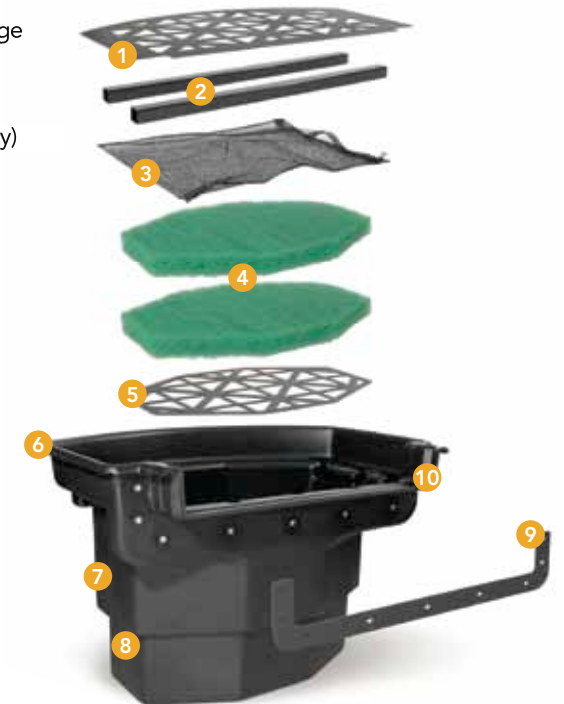

Model BF2600 shown

RECOMMENDED PRODUCTS



Matala Filter Kits, page 24



Bio-Balls, page 24



Biocuda Pond Treatments, page 62

POND KITS



Oasis SERIES POND KIT

- PS3900 Skimmer
- BF1600 FilterFalls
- TW2400 TidalWave2 Pump
- Triton Check Valve
- 1½" x 25' Flexible PVC Pipe
- 15' x 15' Liner
- Heavy-duty Underlayment
- Complete Installation Kit Including Fittings, Thread Sealant and PVC spray glue



Kit No.	Pond Size	Liner Size	Pump	Hose Size
PKOASIS	11' x 11'	15' x 15'	TW2400	1½" x 25'

BioBahama PRO SERIES SMALL POND KITS

- PS4600 Pro Series Skimmer
- BF1900 Pro Series FilterFalls
- TW2 or PAF-Series Pump
- Triton Check Valve
- Flexible PVC Pipe
- 45 mil EPDM pond liner
- Heavy-duty Underlayment
- AWGLED3 pond lights
- AF1000 Auto Fill
- Complete Installation Kit Including Glue, Cleaner, Thread Sealant & (3) 12oz. FallsFoam



	Kit No.	Pond Size	Liner Size	Pump	Hose Size
LOW HEAD HEIGHT	PK191015T	6' x 11'	10' x 15'	TW3700	2" x 25'
	PK191515T	11' x 11'	15' x 15'	TW3700	2" x 25'
	PK191520T	11' x 16'	15' x 20'	TW3700	2" x 25'
HIGH HEAD HEIGHT	PK191015P	6' x 11'	10' x 15'	PAF-20	2" x 25'
	PK191515P	11' x 11'	15' x 15'	PAF-20	2" x 25'
	PK191520P	11' x 16'	15' x 20'	PAF-20	2" x 25'

Our complete Pond Kits offer a convenient, easy and affordable way to achieve a perfectly matched and balanced system. Available with a variety of liner sizes and pump options, with detailed installation instructions included, these Kits provide everything you'll need for a complete, professional installation – no last-minute trips to the hardware store!

BioBahama PRO SERIES MEDIUM POND KITS

- PS7000 Pro Series Skimmer
- BF2600 Pro Series FilterFalls
- TW2 or PAF-Series Pump
- Triton Check Valve
- Flexible PVC Pipe
- 45 mil EPDM pond liner
- Heavy-duty Underlayment
- AWGLED3 pond lights
- AF1000 Auto Fill
- Complete Installation Kit Including Glue, Cleaner, Thread Sealant & (3) 12oz. FallsFoam



	Kit No.	Pond Size	Liner Size	Pump	Hose Size
LOW HEAD HEIGHT	LPK261515T	11' x 11'	15' x 15'	TW4800	2" x 25'
	PK261520T	11' x 16'	15' x 20'	TW4800	2" x 25'
	PK262020T	16' x 16'	20' x 20'	TW4800	2" x 25'
HIGH HEAD HEIGHT	PK261515P	11' x 11'	15' x 15'	PAF-25	2" x 25'
	PK261520P	11' x 16'	15' x 20'	PAF-25	2" x 25'
	PK262020P	16' x 16'	20' x 20'	PAF-25	2" x 25'

BioBahama PRO SERIES LARGE POND KITS

- PS15000 Pro Series Skimmer
- BF3800 Pro Series FilterFalls
- PAF or A-Series Pump
- Triton Check Valve
- Flexible PVC Pipe
- 45 mil EPDM pond liner
- Heavy-duty Underlayment
- AWGLED3 pond lights
- AF1000 Auto Fill
- Complete Installation Kit Including Glue, Cleaner, Thread Sealant & (3) 12oz. FallsFoam



	Kit No.	Pond Size	Liner Size	Pump	Hose Size
HIGH HEAD HEIGHT	PK381520P	11' x 16'	15' x 20'	PAF-75	2" x 50'
	PK382020P	16' x 16'	20' x 20'	PAF-75	2" x 50'
	PK382025A	16' x 21'	20' x 25'	A-31	3" x 50'
	PK382530A	21' x 26'	25' x 30'	A-31	3" x 50'

ACCESSORIES

Whether beautifying your ponds with cosmetic accessories like rock lids, protecting your fish with a Gate Keeper or choosing the right filtration for your setup with a Brush Kit or Matala Mat Kit, Atlantic's accessories allow you to upgrade and customize your Skimmers and FilterFalls to fit your specific water feature.

ROCK LIDS



Say goodbye to that plastic "fake rock" look forever with Atlantic's realistic Rock Lids. Molded from real stones, the sturdy fiberglass construction, authentic textures and incredibly real finishes set these Rock Lids apart from anything else available today. Three sizes and four regional colors ensure the perfect fit for every application. No one will ever know it's not real!

MODELS :

Rock Lids come in four regional colors:
Color representations shown may vary on actual product.

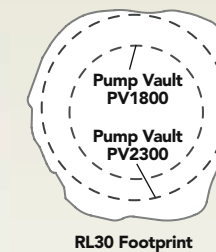

RL30 Footprint

Model: **RL30G Great Lakes**
RL30D Desert
RL30M Mountain
RL30S Southern
Dimensions: 24"L x 24"W x 5"H
Match to Skimmer: PS3900
Match to Pump Vault: PV1800 / PV2300 / RHPV

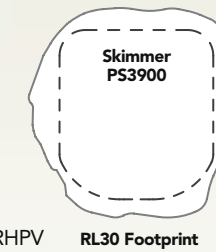

RL30 Footprint



Desert

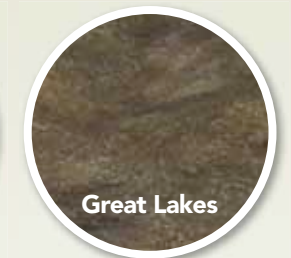

Great Lakes

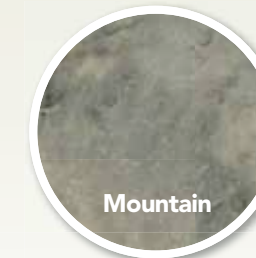

Mountain

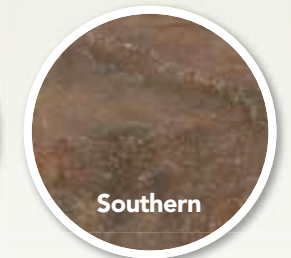

Southern

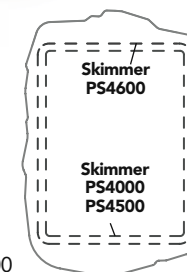

RL40 Footprint

Model: **RL40G Great Lakes**
RL40D Desert
RL40M Mountain
RL40S Southern
Dimensions: 34"L x 24"W x 5"H
Match to Skimmer: PS4000 / PS4500 / PS4600

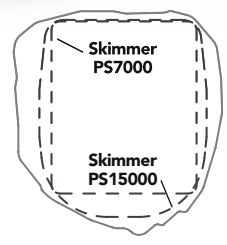

RL70 Footprint

Model: **RL70G Great Lakes**
RL70D Desert
RL70M Mountain
RL70S Southern
Dimensions: 40"L x 36"W x 10"H
Match to Skimmer: PS7000 / PS15000

SKIMMER ACCESSORIES



MEDIA & BAGS

Atlantic's Media Bags are made with triple-stitched, heavy-duty netting and have a convenient drawstring to secure the media within your FilterFalls. Whether using lightweight media blocks, Bio-Balls or heavy lava rocks, Atlantic's Media Bags are meant to last.

MODELS :

Model: BG2234
Description: 18" x 22" Media Bag

Model: BB1000
Description: 1 cubic ft. Bio-Tech Media Blocks with bag



BACK FLUSH KIT

When used with Matala Filter Kits, Atlantic's professional Back Flush Kit virtually eliminates FilterFall maintenance. Add a Back Flush Kit to any Pro Series FilterFalls for fast, convenient, powered backwashing to save you time, trouble and a whole lot of mess.

MODEL :

Model: BFK100
Description: Back Flush Kit for Pro Series FilterFalls



BIO-BALLS

Atlantic's BB1500 contains 150 extremely durable, lightweight Bio-Balls that are easy to clean and reduce channeling. Each ball is 1½" in diameter and has nearly 25 square inches of surface area for bacterial colonization.

MODEL :

Model: BB1500
Description: Bio-Balls 150 pcs.



MATALA FILTER KITS

Customize your FilterFalls with three-stage Matala Filter Kits. Coarse, medium and fine Matala filter mats reduce channeling, increase surface area and are back flushed more effectively than standard filter mats.

MODELS :

Model: MA1600
Description: BF1600 Matala Filter Kit

Model: MA2600
Description: BF2600 Matala Filter Kit

Model: MA1900
Description: BF1900 Matala Filter Kit

Model: MA3800
Description: BF3800 Matala Filter Kit



FILTERFALLS ACCESSORIES

BRUSH KITS

Atlantic's innovative Skimmer Brush Panels provide exceptional debris removal, and unlike dense filter pads, will not block water flow to the pump if neglected. All Pro Series Skimmers can accept an additional brush panel to increase mechanical filtration. Stainless steel and polypropylene construction provide maximum durability.

MODELS :

Model: BK4600
Description: PS4600 Skimmer Brush Kit

Model: BK7000
Description: PS7000 Skimmer Brush Kit

Model: BK15000
Description: PS15000 Skimmer Brush Kit



GATE KEEPERS

Gate Keepers attach to the Skimmer weir to protect your valuable fish by keeping them from swimming into your Skimmer, while still allowing water to pass through.

MODELS :

Model: GK600
Description: Gate Keeper for 6" Super Flow Weir Doors

Model: GK900
Description: Gate Keeper for 9" Super Flow Weir Doors

Model: GK1400
Description: Gate Keeper for 14" Super Flow Weir Doors



BOTTOM DRAIN KIT

A Bottom Drain Kit in your Skimmer makes it easy to keep sludge at bay by pulling debris from the bottom of your pond while the Super Flow weir door skims debris from the surface.

MODEL :

Model: BD2000
Description: Bottom Drain Kit for all Skimmers



MATALA MAT KITS

When used in conjunction with the standard Skimmer Net and Brush Panel, Matala Mat Kits create three-stage mechanical filtration that reduces maintenance and extends the time between skimmer cleaning. Mat Kits fit all Pro Series Skimmers.

MODELS :

Model: MK4600
Description: PS4600 Matala Mat Kit with support frame

Model: MK7000
Description: PS7000 Matala Mat Kit with support frame

Model: MK15000
Description: PS15000 Matala Mat Kit with support frame

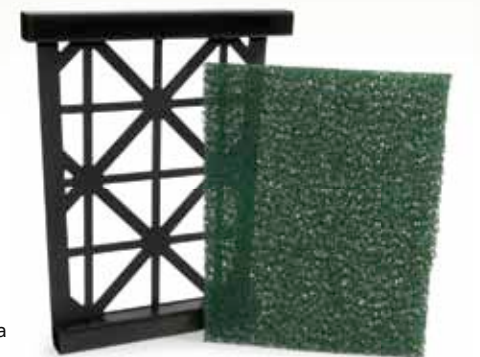

POND-FREE

Atlantic's fully-featured Pond-Free System makes below-ground reservoir construction simpler, easier and more reliable. Sturdy Pump Vaults, Extensions and Eco-Blox reservoirs offer increased safety, lower liability and minimal long-term maintenance. Above ground, our FastFalls lead the industry with tremendous weight capacities and virtually leak-proof design. With the strongest and best-designed components ever built, Atlantic's family of Pond-Free products will last a lifetime.

THE COMPLETE POND-FREE SYSTEM



Where other products warp, crack or leak, Atlantic's Pond-free components just keep on performing. Built with heavy-duty materials designed to last, our Pump Vaults and FastFalls are unsurpassed in the water gardening industry for durability and functionality. Already massively strong and capable, we continue to improve the line, with even stronger formulations and designs that increase capacities once again this year. Available either individually or in complete Kits, our Pond-Free components make your job easier too, with features that keep performing, leak-proof and maintenance-free, for a lifetime.

Pond-free System Features:

- Heavily ribbed Pump Vaults designed for strength and versatility, accommodating multiple pumps for massive flows at the lowest possible operating costs, with knockout ports for perforated pipe for downflow and upflow bog applications.
- Often imitated but never matched, our FastFalls are the sturdiest and easiest to install spillways on the market, with our unique liner attachment system that eliminates leakage regardless of settling.

TYPICAL POND-FREE INSTALLATION

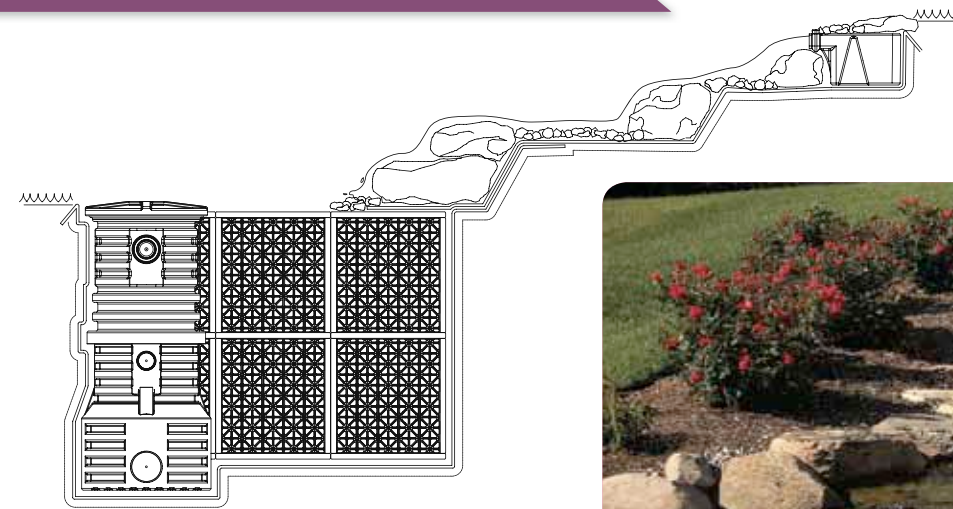

- Redesigned EcoBlox water matrices make water storage even easier, with even greater strength and flexibility this year to safely support massive loads below grade.

Bury these components without a worry - our top quality Pond-free System will perform out of sight and out of mind, flawlessly and worry-free, for years!



SP1600 FastFalls and PV1700 Pump Vault shown

FASTFALLS



Atlantic's immensely strong FastFalls set the standard in spillways, with an internal baffle system stabilized by support cones that cannot be crushed. The 'inside the liner' design with its innovative rear liner attachment simplifies installation and eliminates leakage concerns, while the reinforced spillway lip retains rock, gravel, soil or mulch and can even be planted to blend seamlessly with the surrounding landscape.

Oasis SERIES MODEL:



Model: **SP1600**
 Waterfall Width: 16"
 Dimensions: 16½"W x 9½"D x 7¼"H
 Max Pump Flow: 3,000 gph
 Bulkhead: 1½" FIPT

OASIS FASTFALLS FEATURES:



1. Internal baffles diffuse the water for an even flow across the spillway
2. Raised front radius retains natural camouflage
3. One-piece design eliminates any chance of leaks due to 'overpumping'
4. Pre-installed 1½" Spinweld® fitting simplifies plumbing connection
5. One-piece liner flange and molded inserts ensure a secure liner attachment

Model SP1600 shown

BiaBahama PRO SERIES MODELS:



Model: **SP1900**
 Dimensions: 20½"W x 17"D x 10¼"H
 Waterfall Width: 19"
 Max Pump Flow: 4,000 gph
 Bulkhead: 2" FIPT



Model: **SP2600**
 Dimensions: 27½"W x 17"D x 10¼"H
 Waterfall Width: 26"
 Max Pump Flow: 6,000 gph
 Bulkhead: 2" FIPT



Model: **SP3800**
 Dimensions: 39½"W x 17"D x 10¼"H
 Waterfall Width: 38"
 Max Pump Flow: 9,000 gph
 Bulkhead: 3" FIPT

PRO SERIES FASTFALLS FEATURES:



1. Molded support cones give the Pro FastFalls incredible strength and help diffuse the water flow.
2. Two internal baffles slow down the water's velocity and ensure even water distribution across the spillway.
3. Raised front radius holds back any loose gravel, soil or mulch used to camouflage the top of the unit.
4. Pro FastFalls are completely sealed except for the spillway opening. This design eliminates any chance of leakage due to 'overpumping'.
5. Molded gussets support the spillway lip.
6. Pro FastFalls come with an installed 2" or 3" FIPT Spinweld® fitting.
7. One-piece liner flange and molded inserts ensure a watertight liner attachment every time.

Model SP2600 shown

RECOMMENDED PRODUCTS



Eco-Solv 9, page 63



SOL Lights, pages 56-59



Falls Foam, page 52



When we say you don't have to worry about crushing, cracking or breaking your FastFalls, we mean it! Set your large boulders right on top to camouflage these spillways without a second thought – we test them with a 33,000 lb. Caterpillar 928F Wheel Loader. Now, that's strong!

PUMP VAULTS

Atlantic's heavy-duty one-piece rotomolded Pump Vaults offer all the strength and versatility you need for your Pond-free projects. Liberal volumes and copious flow capacities handle multiple pump configurations and larger pumps, while strong, tightly-fitting covers and generous openings provide easy pump and pipe access.



Vault Extensions the same height as our EcoBlox open the way for deeper basins, larger reservoirs and greater water volumes. Flat panels and multiple cut lines for various sizes of solid and perforated pipe allow almost limitless plumbing options, to easily accommodate any project from mighty waterfalls to rainwater cisterns and downflow bogs.

Oasis SERIES MODEL :



Model: **PV1700**
Dimensions: 17"W x 12"D x 22½"H
Max Pump Flow: 3,900 gph
Opening: 10"

OASIS PUMP VAULT FEATURES:

1. Inset lid keeps gravel from falling into the vault
2. Pump discharge step fittings for 1½" & 2" pipe provided on both sides of the vault
3. Flat front panel installs tight against Eco-Blox for a compact basin
4. Recessed pockets accept Triton 3-Way Diverter for use with the Eco-Rise (see pg. 38)
5. Flat panel for 1½" pipe for use with the Eco-Rise



Model PV1700 shown

Big Bahama PRO SERIES MODELS :



Model: **PV1800**
Dimensions: 18"W x 24"H
Max Pump Flow: 10,000 gph
Opening: 14"



Model: **PV18EXT**
Dimensions: 16½"W x 19½"H
Extension: 17"

PRO PUMP VAULT FEATURES:

1. Large opening allows easy access to pump and plumbing
2. Ribbed lid for added strength
3. Flat panels for Auto Fill installation and custom plumbing applications
4. Pre-drilled discharge for 2" pipe
5. Cut line for 4" SDR35 pipe



Model PV1800 shown

RECOMMENDED PRODUCTS



Auto Fill Kit, page 52



Triton Ionizer, page 61



Biocuda Water Treatments, page 63



Model: **PV2300**
Dimensions: 23"W x 30"H
Max Pump Flow: 15,000 gph
Opening: 18"



Model: **PV23EXT**
Dimensions: 21½"W x 19½"H
Extension: 17"

ECO-BLOX

Atlantic's proprietary Eco-Blox water matrix saves you time and money on all your rainwater harvesting, stormwater management and pond-free installations. With 96% void space, Eco-Blox reservoirs store large volumes of water easily and economically. Underground and out of sight, their enormous strength allows for landscaping right over the reservoir.



POND-FREE KITS

Atlantic's complete Pond-free Kits take all the guesswork out of selecting the perfect components for your project. We provide detailed instructions, match the Eco-Blox and reservoir liner to the stream length and add the right Vault and matching pump, an Auto-Fill valve – our Pro Kits even come with an LED light set! As with all our Kits, you get everything you'll need for a complete, professional installation, from pump to plumbing, fittings to foam, sealant to cement, with no last-minute trips to the hardware store!

MODEL:

EXTRA HEAVY-DUTY CROSSBARS FOR IMPROVED POINT LOAD STRENGTH

Model: **ECOBLOX**
 Dimensions: 27"L x 16"W x 17½"H
 Capacity: 31½ Gallons
 Application: Pond-free / Fountain / Rain Harvesting

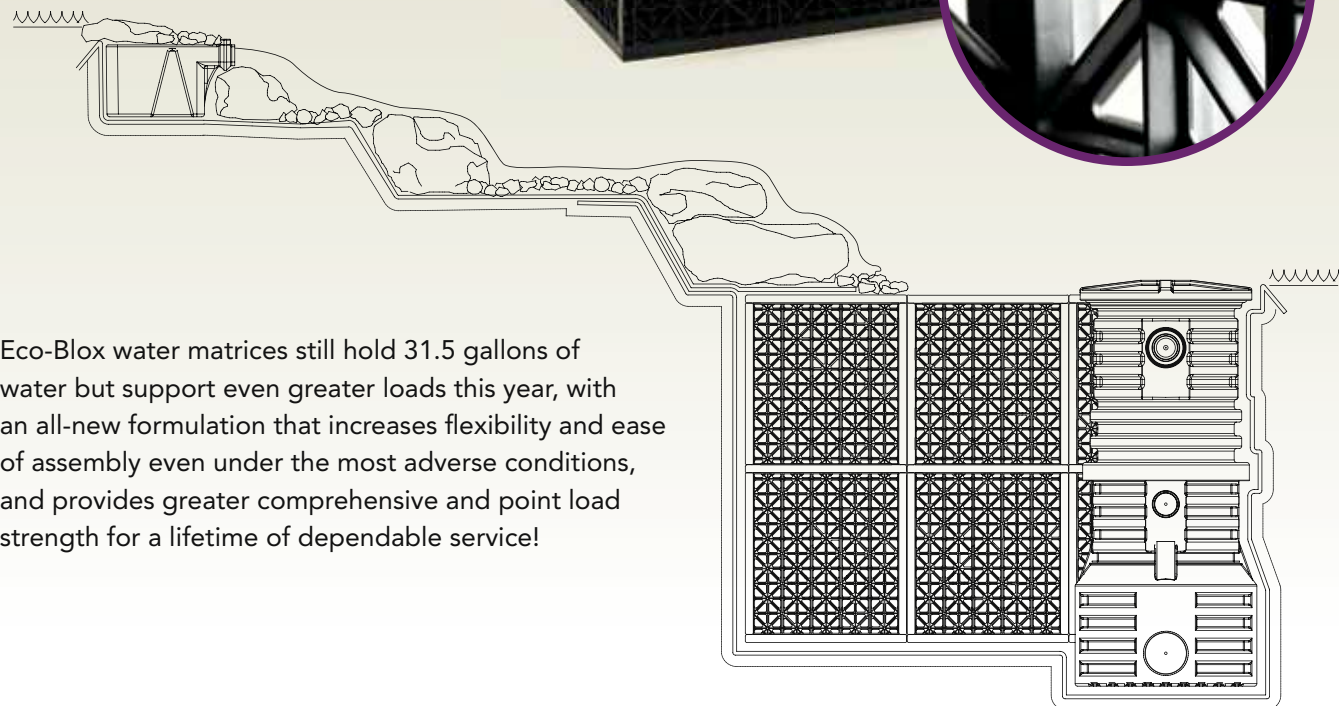

Eco-Blox water matrices still hold 31.5 gallons of water but support even greater loads this year, with an all-new formulation that increases flexibility and ease of assembly even under the most adverse conditions, and provides greater comprehensive and point load strength for a lifetime of dependable service!

Oasis SERIES POND-FREE KIT

- SP1600 FastFalls
- PV1700 Pump Vault
- TW2400 TidalWave2 Pump
- Triton Check Valve
- 1½" x 25' Flexible PVC Pipe
- 2 Eco-Blox
- 10' x 15' liner
- Heavy-duty Underlayment
- Complete Installation Kit Including Fittings, Thread Sealant and PVC Spray Glue



Kit No.	Liner Size	Eco-Blox	Basin Size	Streambed
PKOASISPL	10' x 15'	2	48" x 30" x 18"	16" - 24"W x 6'L

BioBahama PRO SERIES POND-FREE KITS

- PV1800 Pump Vault
- Pro Series FastFalls
- TidalWave2 Pump
- Triton Check Valve
- 2" x 25' Flexible PVC Pipe
- 45 mil EPDM pond liner
- Heavy-duty Underlayment
- Eco-Blox
- AWGLED3 pond lights
- AF1000 Auto Fill
- Complete Installation Kit Including Glue, Cleaner, Thread Sealant & (3) 12oz. FallsFoam



Kit No.	Liner Size	FastFalls	Eco-Blox	Pump	Basin Size	Streambed
PK1819PL	10' x 15'	SP1900	3	TW3700	54" x 32" x 18"	19" - 24"W x 6'L
PK1826PL	10' x 20'	SP2600	5	TW4800	54" x 48" x 18"	26" - 32"W x 10'L

FOUNTAIN

Atlantic's Fountain System is the easiest, fastest and strongest way to build a water feature, with heavy duty components designed to work together to beautify any hardscape. Choose from a variety of light and water displays that combine to captivate and enthrall!

THE COMPLETE FOUNTAIN SYSTEM

Atlantic's Fountain Basins are the strongest and most fully featured available, with integrated internal supports to handle huge weights, a sturdy, rigid platform, integrated tubing channels to keep all the plumbing above water and safe from kinking and room for up to three individual decorative elements. For even more versatility, our new Eco-Rise/Eco-Blox System allows complete control of up to six elements from a single vault over a reservoir of any size or shape. To top off our basin choices, check out Atlantic's newest additions, Pebble Pots, Color Changing Vases and our faux Basalt Columns, for every landscape, taste and budget.



Fountain System Features:

- High capacity, generous diameter Fountain Basins offer ample water storage, integrated flow controls and automatic fill valves to control water loss and keep maintenance to a minimum.
- Our fountain toppers are custom designed to work flawlessly with their companion Basins for easy matching and fast, foolproof assembly, with integrated lighting options for stunning displays before and after sundown.
- Create your own custom Eco-Blox water matrix reservoir of any depth, size or shape and place an unlimited number of decorative elements right on top, with full valved control of each. Add rainwater harvesting for a truly versatile use of reservoir.

Typical Fountain Basin Installation:

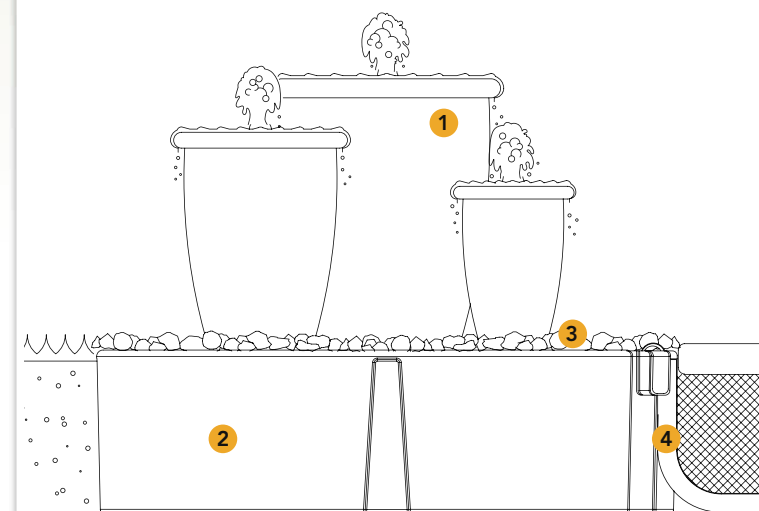

1. Fountain Elements
2. FB4600 Fountain Basin
3. Decorative Gravel
4. Conduit sleeve for electrical cords

ECO-RISE SYSTEM

ECO-RISE

The extremely strong radial structure handles the weight of heavier statuary, vases and columns while providing a broad stable base over Eco-Blox reservoirs. The versatility of the Eco-Rise used in conjunction with Eco-Blox, PV1700 Pump Vault and Triton 3-Way Diverter allows for multiple features in any configuration above odd basin shapes, while keeping plumbing and flow adjustment topside for easy access.

Works in conjunction with Pro Series Eco-Blox found on page 32 in the Pond-free Section.

MODEL :



Model: **ECORISE20**
 Dimensions: 20"L x 20"W x 3"H
 Plumbing Size: 3/4" to 1 1/2"
 Max Load: 3,000 lbs.



TRITON 3-WAY DIVERTER

The Triton 3-Way Diverter is the only manifold designed exclusively for pond-free fountain installations. The 1 1/2" inlet allows unrestricted flow into the manifold, delivering the maximum possible volume to all three of the 3/4" outlets. True 'ball' style valves with removable handles enable independent flow adjustment of each outlet. The compact design makes it a perfect fit for installation in all Pump Vaults and Fountain Basins.

MODEL :



Model: **TR3WAY**
 Dimensions: 5 3/8"L x 4 1/2"W x 2 7/8"H
 Inlet: 1 1/2" FIPT
 Outlet: (3) 3/4" Insert
 Includes: (2) removable "T" handles

TYPICAL FOUNTAIN ECO-RISE INSTALLATION



PV1700 Pump Vault shown with 3-Way Diverter installed for use with the Eco-Rise and Eco-Blox. Add a second pump and a second 3-Way Diverter to control up to six water features from a single PV1700 Vault.

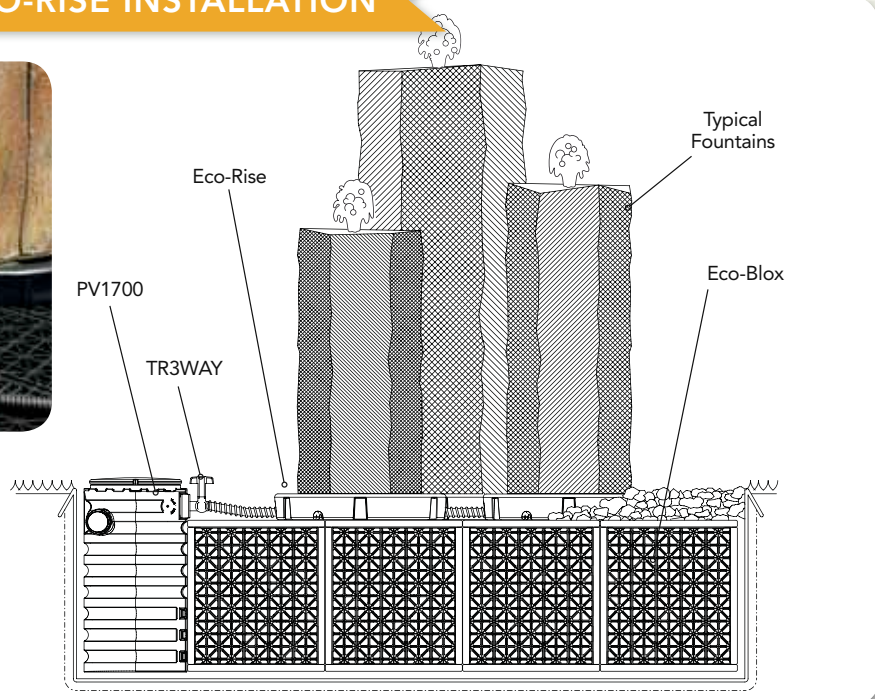

FOUNTAIN BASINS

When they were introduced, Atlantic Fountain Basins were already the strongest and best-designed on the market, featuring deep plumbing channels on top of the basins, easy access pump chambers and external flow adjustment for convenient installation and maintenance. Now they're even better, with new internal buttressing cones for greater rigidity. Count on Atlantic to keep on performing!

MODELS :



Model: **FB2400**
 Dimensions: 24"L x 24"W x 10"H
 Max Pump Flow: 750 gph
 Plumbing Size: Up to 1/2"
 Capacity: 20 Gallons
 Supports Up To: 200 lbs.



Model: **FB3200**
 Dimensions: 32"W x 13"H
 Max Pump Flow: 2,000 gph
 Plumbing Size: (3) 3/4" or (1) 1" hose
 Capacity: 32 Gallons
 Supports Up To: 400 lbs.



Model: **FB4600**
 Dimensions: 46"W x 13"H
 Max Pump Flow: 4,000 gph
 Plumbing Size: (3) 3/4" or (1) 1 1/2" hose
 Capacity: 67 Gallons
 Supports Up To: 1,200 lbs.

PRO SERIES FOUNTAIN BASIN FEATURES:

1. One-piece construction provides exceptional strength.
2. Built-in channels simplify installation, allowing the plumbing to be run on top of the basin.
3. Seven molded cones support the top panel.
4. Recessed pocket accepts the Triton 3-Way Diverter. Adjusting the water flow to multiple pieces has never been easier.
5. Recessed 1 1/2" conduit recesses allow for clean installation in surrounding masonry without notching
6. Flat panel for optional AF1000 Auto Fill installation

Model FB4600 shown

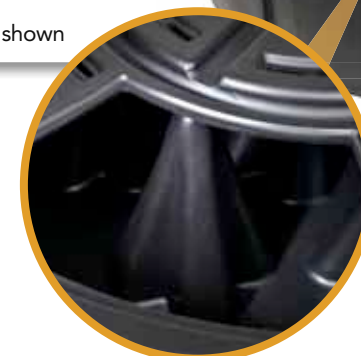

INTERNAL CONE SUPPORT SYSTEM

Pro Series Plumbing Kits*



Part No. **FBKIT1**
 For Use With: FP200 - 500 & MD250 - 750

- Single ball valve
- 6' of 3/4" diameter kink-free hose
- (1) standpipe sealant strip
- 3/4" insert x 3/4" socket fitting
- 1 1/2" cord stopper for conduit sleeve

* 3/4" PVC standpipe & pump not included



Part No. **FBKIT3**
 For Use With: TW1200 - 2400 & MD1000 - 2000

- Triton 3-Way Diverter
- 20' of 3/4" diameter kink-free hose
- (3) standpipe sealant strips
- (3) 3/4" insert x 3/4" socket fittings
- (2) 1 1/2" cord stoppers for conduit sleeves

* 3/4" PVC standpipe & pump not included

FOUNTAINS



MODELS:

Model: FTN PP20
 Description: Fiberglass Pebble Pot
 Inlet: 3/4" insert fitting
 Dimensions: 11"W x 20"H
 For Use With: FB2400 Basin & FP300 pump

Model: FTN PP43
 Description: Fiberglass Pebble Pot
 Inlet: 3/4" insert fitting
 Dimensions: 24"W x 43"H
 For Use With: FB4600 Basin & FP500 pump

Model: FTN PP32
 Description: Fiberglass Pebble Pot
 Inlet: 3/4" insert fitting
 Dimensions: 18"W x 32"H
 For Use With: FB3200 Basin & FP400 pump



Add an AWGFT2 Fountain Light to combine a splash of warming light with the sound of water! Page 55



Model: FTN BC16
 Description: Fiberglass Basalt Column
 Inlet: 3/4" insert fitting
 Dimensions: 9"W x 16"H
 For Use With: FB2400 Basin & FP200 pump

Model: FTN BC30
 Description: Fiberglass Basalt Column
 Inlet: 3/4" insert fitting
 Dimensions: 15"W x 30"H
 For Use With: FB3200 Basin & FP400 pump

Model: FTN BC22
 Description: Fiberglass Basalt Column
 Inlet: 3/4" insert fitting
 Dimensions: 12"W x 22"H
 For Use With: FB3200 Basin & FP300 pump

Model: FTN BCX3
 Description: 3pc. Basalt Column Set
 Inlet: (3) 3/4" insert fittings
 Includes: FTN BC16, BC22 & BC30
 For Use With: FB4600 Basin, FBKIT3 & MD1000 pump

FOUNTAIN KITS

Atlantic's Fountain Kits come with everything you need except the water! The fastest, easiest way to create a beautiful self-contained fountain, just connect the adjustable flow pump, fill up the sturdy basin and plug in the pump. Select either a rustic realistic Basalt Column, charming hand painted Pebble Pot or radiant Color Changing Vase. The perfect complement to any garden, these elegant fountains eliminate weight and safety concerns while retaining all the charm and durability of natural materials.

MODELS:



Model: FKBC16
 Description: Basalt Column Fountain Kit
 Includes: FB2400 Basin, FTN BC16 Basalt Column, FP200 pump and fittings



Model: FKPP20
 Description: Pebble Pot Fountain Kit
 Includes: FB2400 Basin, FTN PP20 Pebble Pot, FP200 pump and fittings



Model: FKCCV18
 Description: Color Changing Vase Fountain Kit
 Includes: FB2400 Basin, FTN CCV18 Color Changing Vase, FP200 pump and fittings

COLOR CHANGING FOUNTAINS:

During the day the three sizes create the welcome sights and sounds of dancing water, bubbling up and cascading down their sides – but in the dark, they come alive with light! Working on the same technology as our Color Changing Colorfalls, these vases radiate in 48 different colors, or in 16 different pre-programmed patterns, with speed and intensity regulated by Remote Control.



PATENT PENDING



- Color Changing LED Light Ring, Remote Control and Control Module
- Integrated anchor base for increased stability
- Durable rotomolded polyethylene construction
- Simulated granite finish
- Sold individually or as a 3-piece Kit

EACH COLOR CHANGING VASE INCLUDES LED LIGHT RING, SOL CONTROL MODULE & REMOTE

Model: FTN CCV18
 Description: Color Changing Vase
 Inlet: 3/4" PVC pipe
 Dimensions: 10"W x 18"H
 For Use With: FB2400 Basin, FBKIT1 & FP200 pump

Model: FTN CCV24
 Description: Color Changing Vase
 Inlet: 3/4" PVC pipe
 Dimensions: 12"W x 24"H
 For Use With: FB3200 Basin, FBKIT1 & FP300 pump

Model: FTN CCV32
 Description: Color Changing Vase
 Inlet: 3/4" PVC pipe
 Dimensions: 14"W x 32"H
 For Use With: FB3200 Basin, FBKIT1 & FP400 pump

Model: FTN CCVX3
 Description: 3pc. Color Changing Vase Set
 Inlet: (3) 3/4" PVC pipe
 Includes: FTN CCV18, CCV24 & CCV32
 For Use With: FB4600 Basin, FBKIT3 & MD1000 pump

PUMPS

Atlantic's Pump Products offer the perfect solution for all water features, large and small. Whether the application calls for Mag Drive or Direct Drive, Axial or Asynchronous, TidalWave pumps deliver the right flow at the right head for the right wattage. Cutting edge design, top quality components and world class support ensure TidalWave delivers years of trouble-free service.

TidalWave COMPREHENSIVE PUMP CHART

Atlantic's Comprehensive Pump Chart provides clear, easy-to-understand Best Efficiency Points and Recommended Operating Ranges, to ensure the perfect match of pump to application. Choosing the perfect pump for your water feature is easy:

Estimate the Total Dynamic Head of your system (see below) and then find the desired GPH at that head height. For best results make sure the pump chosen is operating in its Best Efficiency (dark blue) range to avoid cavitation, overheating and overworking, ensuring years of worry-free service. For more in-depth information, see Atlantic's "Let's Talk Pumps" Tri-fold.

	Model #	Watts	Max	5'	10'	15'	20'	25'	30'	35'	40'	45'	50'	55'	60'
MAG DRIVE SERIES	MD250	15	300												
	MD350	25	370	145											
	MD550	40	650	385											
	MD750	50	790	465											
	MD1000	90	1080	785	275										
	MD1250	120	1330	1040	580										
	MD1500	165	1560	1255	780										
	MD2000	250	2010	1695	1320	695									
HYBRID SERIES	TW1200	110	1290	1080	720										
	TW1900	130	1900	1440	900										
	TW2400	175	2400	1950	1390	825									
	TW3700	355	3730	3010	2230	1425									
	TW4800	425	4800	4000	3140	2230	1260								
	TW6000	495	6000	5040	4050	3000	1930								
SH-SERIES	SH1450	240	1450	1170	650										
	SH2050	320	2050	1700	1130										
	SH3600	575		3245	2750	2090									
	SH5000	950		4350	3620	2800									
	SH6500	1000			4875	4000	3080								
PAF-SERIES	PAF-20	360		2800	1950	1080									
	PAF-25	545		3900	3150	2300									
	PAF-40	650			4350	3570	2700								
	PAF-75	900				4560	3750	2830							
A-SERIES	A-05	645					2155	1875	1450	935					
	A-05L	725			4320	3600	2820	1920							
	A-21	1060					4335	3770	3140	2400					
	A-31	1160			8150	6830	5535	4120	2535						
	A-32	2055								8280	7560	6780	5580	4920	
L-SERIES	L-305	710		10380	7380										
	L-310	1105		13500	10560	7380									

■ Recommended Operating Range
 ■ Best Efficiency Point
 ■ Do Not Operate Range

* Total Dynamic Head (TDH) is a critical measure of the work a pump will have to do; if GPH is the size of the bucket, TDH is the hill it's carried up. Figuring TDH is as easy as it is important. Take the height of your waterfall or stream; add 1 ft. for every 10 ft. of tubing, 1 ft. for every fitting to compensate for plumbing friction. Take the total to the Comprehensive Pump Chart to find the perfect pump for your application.

TidalWave

MAG DRIVE SERIES

TidalWave magnetic induction pumps are the perfect choice for small water features with low head heights. Hefty and heavy-duty, equipped with removable pre-filters, oversized ceramic shafts, replaceable impeller assemblies and a 20' power cord, Atlantic Mag Drives are the ones you've been waiting for. With great energy efficiency and a five-year warranty, these pumps are winners!



FOUNTAIN HEADS

Add another dimension to your water garden with Atlantic's Fountain Heads. Compatible with all of Atlantic's Mag Drive Pumps, these versatile Fountain Heads pivot to make leveling easy, telescope to adjustable heights and feature four different spray patterns to choose from.

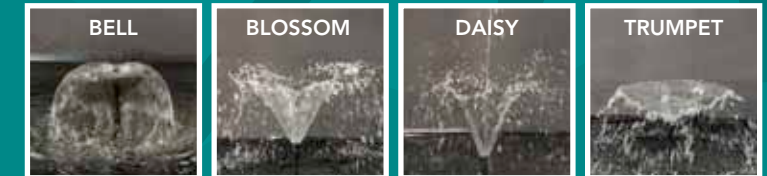

MODELS:

Model: MD250
 Volts: 115
 Watts: 15
 Inlet: 1" MIPT
 Outlet: 3/4" MIPT
 Dimensions: 4 1/2" L x 3 1/2" W x 5" H
 Includes: Pre-filter, 3/4" - 1" outlet fitting

Model: MD350
 Volts: 115
 Watts: 25
 Inlet: 1" MIPT
 Outlet: 3/4" MIPT
 Dimensions: 4 1/2" L x 3 1/2" W x 5" H
 Includes: Pre-filter, 3/4" - 1" outlet fitting

Model: MD550
 Volts: 115
 Watts: 40
 Inlet: 1" MIPT
 Outlet: 3/4" MIPT
 Dimensions: 4 1/2" L x 3 1/2" W x 5" H
 Includes: Pre-filter, 3/4" - 1" outlet fitting

Model: MD1250
 Volts: 115
 Watts: 120
 Inlet: 1 1/2" MIPT
 Outlet: 1" MIPT
 Dimensions: 5 1/2" L x 4 1/4" W x 5 1/2" H
 Includes: Pre-filter, 1" - 1 1/2" outlet fitting

MD1000
MD1250

MD250
MD350
MD550
MD750



* Wattage is calculated @ BEP using the following formula (Volts x Amps x PF = Watts).

Model #	Watts	Max	5'	10'	15'	20'	25'	30'
MD250	15	300						
MD350	25	370	145					
MD550	40	650	385					
MD750	50	790	465					
MD1000	90	1080	785	275				
MD1250	120	1330	1040	580				
MD1500	165	1560	1255	780				
MD2000	250	2010	1695	1320	695			

Recommended Operating Range Best Efficiency Point Do Not Operate Range

Model: MD750
 Volts: 115
 Watts: 50
 Inlet: 1" MIPT
 Outlet: 3/4" MIPT
 Dimensions: 4 1/2" L x 3 1/2" W x 5" H
 Includes: Pre-filter, 3/4" - 1" outlet fitting

Model: MD1500
 Volts: 115
 Watts: 165
 Inlet: 1 1/2" MIPT
 Outlet: 1" MIPT
 Dimensions: 6" L x 4 3/4" W x 6" H
 Includes: Pre-filter, 1" - 1 1/2" outlet fitting

Model: MD1000
 Volts: 115
 Watts: 90
 Inlet: 1 1/2" MIPT
 Outlet: 1" MIPT
 Dimensions: 5 1/2" L x 4 1/4" W x 5 1/2" H
 Includes: Pre-filter, 1" - 1 1/2" outlet fitting

Model: MD2000
 Volts: 115
 Watts: 250
 Inlet: 1 1/2" MIPT
 Outlet: 1" MIPT
 Dimensions: 6" L x 4 3/4" W x 6" H
 Includes: Pre-filter, 1" - 1 1/2" outlet fitting



Model: MDFH2575
 Description: Telescoping Fountain Head
 Min Height: 12"
 Max Height: 18"
 Inlet: 3/4" FIPT
 Outlet: 1/2" insert
 For Use With: 250 - 750 gph MD pumps
 Includes: Telescoping diverter w/ 4 interchangeable fountain heads



Model: MDFH1020
 Description: Telescoping Fountain Head
 Min Height: 15"
 Max Height: 22"
 Inlet: 1" FIPT
 Outlet: 1" MIPT
 For Use With: 1000 - 2000 gph MD pumps
 Includes: Telescoping diverter w/ 4 interchangeable fountain heads

MAG DRIVE PUMP FEATURES:

1. Oversized male threaded inlet and outlet for less restriction and greater flow
2. Rotating volute provides maximum adaptability for any installation
3. Half twist volute provides access to the impeller assembly without the use of tools
4. Large, stable base is removable for added versatility
5. Removable pre-filter provides increased surface area and reduces maintenance
6. Tapered outlet fittings accept a wide array of tubing sizes
7. MD1000 - MD2000 include a 1 1/2" adapter for use with the Triton Check Valve and Fountain Basin Plumbing Kits (not shown)



5-year warranty

TidalWave

FOUNTAIN PUMP SERIES

Atlantic's Fountain Pumps offer everything you want in a small pump line, with large, sturdy pre-filters, integrated flow controls, versatile base plates and small diameter power plugs. Sized to fit even the smallest applications, these pumps still deliver big performance, with higher head heights and lower wattages than the competition. Trust Atlantic for all your fountain pump needs!

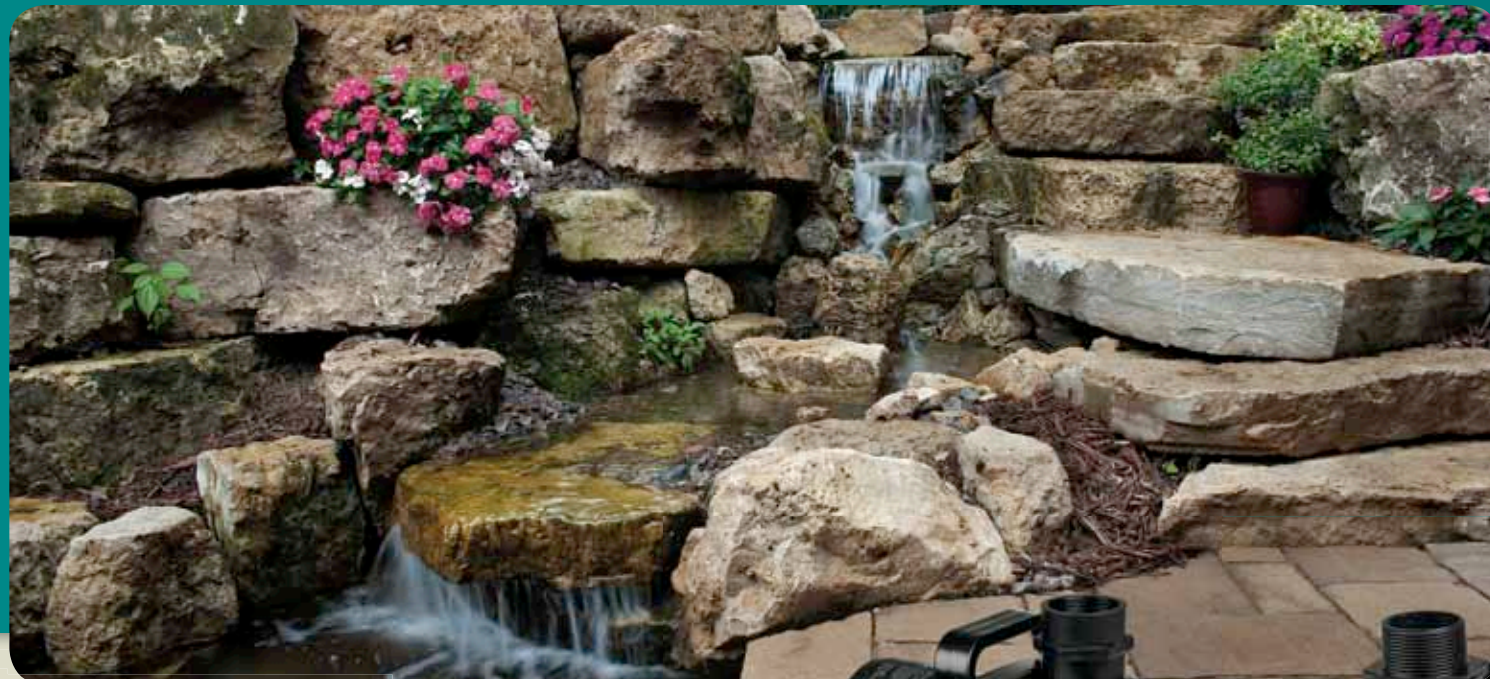

TidalWave²

HYBRID PUMP SERIES

TidalWave2 asynchronous pumps are the perfect choice for high flow, medium head applications where energy consumption is a factor. Efficient vortex impellers driven by asynchronous magnetic induction provide great hybrid performance, delivering direct drive output at magnetic drive efficiency. Compact, powerful TidalWave2 Hybrid Pumps offer the best of both worlds.



FP100
FP200



FP300
FP400



FP500

MODELS :

Model: FP100
Volts: 115
Watts: 7
Outlet: 1/2" MIPT
Cord: 6'
Dimensions: 3 1/2"L x 2 1/4"W x 2 1/2"H
Includes: Adjustable flow pre-filter & 1/2" - 3/4" outlet fitting

Model: FP200
Volts: 115
Watts: 9.5
Outlet: 1/2" MIPT
Cord: 6'
Dimensions: 3 1/2"L x 2 1/4"W x 2 1/2"H
Includes: Adjustable flow pre-filter & 1/2" - 3/4" outlet fitting

Model: FP300
Volts: 115
Watts: 16
Outlet: 1/2" FIPT
Cord: 16'
Dimensions: 5"L x 3"W x 3 1/4"H
Includes: Adjustable flow pre-filter & 1/2" - 3/4" outlet fitting

Model: FP400
Volts: 115
Watts: 24
Outlet: 1/2" FIPT
Cord: 16'
Dimensions: 5"L x 3"W x 3 1/4"H
Includes: Adjustable flow pre-filter & 1/2" - 3/4" outlet fitting

Model: FP500
Volts: 115
Watts: 33
Outlet: 1/2" FIPT
Cord: 16'
Dimensions: 5 1/4"L x 3 1/2"W x 4"H
Includes: Adjustable flow pre-filter & 1/2" - 3/4" outlet fitting

FOUNTAIN PUMP FEATURES:

- Removable pre-filter
- Integrated flow adjustment
- Replaceable impeller
- 1-year warranty

* Wattage is calculated @ BEP using the following formula (Volts x Amps x PF = Watts).

Model #	Watts	Max	2.5'	5'	7.5'
FP100	7	120			
FP200	9.5	175	100		
FP300	16	325	230	90	
FP400	24	370	290	180	
FP500	33	525	430	300	75

Best Efficiency Range



TW3700
TW4800

TW1200
TW1900
TW2400



TW6000



TW² SERIES PUMP FEATURES:

- Epoxy encapsulated asynchronous motor
- Replaceable vortex impeller
- Wear-proof ceramic shaft
- 32' power cord
- 2-year warranty

* Wattage is calculated @ BEP using the following formula (Volts x Amps x PF = Watts).

Model #	Watts	Max	5'	10'	15'	20'	25'	30'
TW1200	110	1290	1080	720	180			
TW1900	130	1900	1440	900	360			
TW2400	175	2400	1950	1390	825	220		
TW3700	355	3730	3010	2230	1425	660		
TW4800	425	4800	4000	3140	2228	1260	240	
TW6000	495	6000	5040	4050	3000	1930	852	

Recommended Operating Range Best Efficiency Point Do Not Operate Range

MODELS :

Model: TW1200
Volts: 115
Amps: 0.9
Watts: 110
Inlet: 1 1/2" MIPT
Outlet: 1 1/2" FIPT
Dimensions: 8 1/2"L x 5"W x 6"H

Model: TW3700
Volts: 115
Amps: 2.95
Watts: 355
Inlet: 2" MIPT
Outlet: 1 1/2" FIPT
Dimensions: 10"L x 6"W x 7"H

Model: TW1900
Volts: 115
Amps: 1.1
Watts: 130
Inlet: 1 1/2" MIPT
Outlet: 1 1/2" FIPT
Dimensions: 8 1/2"L x 5"W x 6"H

Model: TW4800
Volts: 115
Amps: 3.55
Watts: 425
Inlet: 2" MIPT
Outlet: 1 1/2" FIPT
Dimensions: 10"L x 6"W x 7"H

Model: TW2400
Volts: 115
Amps: 1.45
Watts: 175
Inlet: 1 1/2" MIPT
Outlet: 1 1/2" FIPT
Dimensions: 8 1/2"L x 5"W x 6"H

Model: TW6000
Volts: 115
Amps: 4.15
Watts: 495
Inlet: 2" MIPT
Outlet: 2" FIPT
Dimensions: 10"L x 6"W x 7"H

TidalWave

SH-SERIES PUMPS

A mainstay of the Water Garden Industry, TidalWave SH-Series Pumps have proven to be one of the most dependable and energy-efficient composite direct drives available. With true solids handling capacities of up to 1½" and stable base geometry, these value-packed pumps excel under the most rigorous conditions.



TidalWave

PAF PUMP SERIES

Lightweight, energy efficient and corrosion resistant, TidalWave PAF-Series Pumps are now even more versatile, with a removable intake screen for conversion to true 1¼" solids handling capacity. Sharing the same high quality internal components as our A-Series, PAF direct drive pumps are perfect for demanding medium head, high volume applications.



SH5000
SH6500



SH1450
SH2050
SH3600

SH-SERIES PUMP FEATURES:

- Non-corrosive and handles solids
- Oil-Free design
- Vortex Impeller
- Overload and thermal protection
- 16' power cord
- 2-year warranty

* Wattage is calculated @ BEP using the following formula (Volts x Amps x PF = Watts).

Model #	Watts	Max	5'	10'	15'	20'	25'	30'	35'
SH1450	240	1450	1170	650					
SH2050	320	2050	1700	1130	235				
SH3600	575	3600	3245	2750	2090	1210			
SH5000	950	5000	4350	3620	2800	1875	825		
SH6500	1000	6500	5710	4875	4000	3080	2110	1085	

*Operating pumps outside of the recommended range may cause bearing damage and premature failure.

Recommended Operating Range Best Efficiency Point Do Not Operate Range

MODELS:

Model: SH1450
Volts: 115
Amps: 2.1
Watts: 240
Outlet: 1¼" FIPT w/ 1½" FIPT elbow
Dimensions: 6"L x 9"W x 11¾"H

Model: SH2050
Volts: 115
Amps: 2.8
Watts: 320
Outlet: 1¼" FIPT w/ 1½" FIPT elbow
Dimensions: 6"L x 9"W x 12½"H

Model: SH3600
Volts: 115
Amps: 5.5
Watts: 575
Outlet: 1¼" FIPT w/ 1½" FIPT elbow
Dimensions: 6"L x 9"W x 14"H

Model: SH5000
Volts: 115
Amps: 9
Watts: 950
Outlet: 1½" FIPT w/ 1½" FIPT elbow
Dimensions: 9½"L x 12"W x 15¾"H

Model: SH6500
Volts: 115
Amps: 9.5
Watts: 1000
Outlet: 1½" FIPT w/ 1½" FIPT elbow
Dimensions: 9½"L x 12"W x 15¾"H



PAF-20

PAF-25

PAF-40

PAF-75

* Wattage is calculated @ BEP using the following formula (Volts x Amps x PF = Watts).



PAF SERIES PUMP FEATURES:

- Stainless steel and composite construction
- Double silicon carbide mechanical seals
- Fiber reinforced vortex impeller
- 20' power cord
- 2-year warranty



Removable screen for solids handling capability

MODELS:

Model: PAF-20
Motor: 1/4 HP
Volts: 115
Amps: 3.5
Watts: 360
Outlet: 2" FIPT
Dimensions: 9"L x 6"W x 14"H

Model: PAF-25
Motor: 1/3 HP
Volts: 115
Amps: 5
Watts: 545
Outlet: 2" FIPT
Dimensions: 9"L x 6"W x 14½"H

Model #	Watts	Max	5'	10'	15'	20'	25'	30'	35'
PAF-20	360	--	2800	1950	1080	180			
PAF-25	545	--	3900	3150	2300	1350	240		
PAF-40	650	--	4950	4350	3570	2700	1700	520	
PAF-75	900	--	5950	5270	4560	3750	2830	1770	550

*Operating pumps outside of the recommended range may cause bearing damage and premature failure.

Recommended Operating Range Best Efficiency Point Do Not Operate Range

Model: PAF-40
Motor: 1/2 HP
Volts: 115
Amps: 6
Watts: 650
Outlet: 2" FIPT
Dimensions: 9"L x 6"W x 15"H

Model: PAF-75
Motor: 1 HP
Volts: 115
Amps: 8.5
Watts: 900
Outlet: 2" FIPT
Dimensions: 9"L x 6"W x 16"H

TidalWave

A-SERIES PUMPS

TidalWave A-Series are manufactured from cast iron and stainless steel with precision motors and thermal overload protection. These professional-grade direct drive pumps are engineered for demanding high volume applications and perform where most cannot.



A & L-SERIES PUMP FEATURES:

- Cast iron vortex impeller
- Double silicon carbide mechanical seals
- Dual drive bearings
- Auto-cut thermal protection
- 30' power cord
- 2-year warranty



TidalWave

L-SERIES PUMPS

TidalWave L-Series are axial flow pumps, specially designed to deliver high volumes through large diameter plumbing to relatively low heights. Under 10' of head, the low power consumption of these 3" outlet pumps can't be beat for your high flow applications. Built with the same robust cast iron and stainless steel construction as our A-Series, Atlantic's L-Series pumps will deliver for years.



MODELS:

Model: **L-305** Motor: 1/2 HP
 Volts: 115 Amps: 6.4
 Watts: 710 Outlet: 3" MPT
 Weight: 60 lbs.
 Dimensions: 9"L x 9"W x 19 1/4"H

Model: **L-310** Motor: 1 HP
 Volts: 115 Amps: 10
 Watts: 1105 Outlet: 3" MPT
 Weight: 65 lbs.
 Dimensions: 9"L x 9"W x 19 1/4"H

Model #	Watts	Max	5'	10'	15'	20'	25'	30'	35'	40'	45'	50'	55'	60'
L-305	710	--	10380	7380	3960									
L-310	1105	--	13500	10560	7380	3240								



* Wattage is calculated @ BEP using the following formula (Volts x Amps x PF = Watts).

*Operating pumps outside of the recommended range may cause bearing damage and premature failure.

Recommended Operating Range Best Efficiency Point Do Not Operate Range

* Wattage is calculated @ BEP using the following formula (Volts x Amps x PF = Watts).

MODELS:

Model: **A-05** Motor: 1/2 HP
 Volts: 115 Amps: 5.4
 Watts: 645 Outlet: 2" FIPT
 Weight: 32 lbs.
 Dimensions: 9"L x 6 1/4"W x 15"H

Model: **A-31** Motor: 1 HP
 Volts: 115 Amps: 10
 Watts: 1160 Outlet: 3" FIPT
 Weight: 48 lbs.
 Dimensions: 11"L x 7"W x 18"H

Model: **A-32** Motor: 2 HP
 Volts: 230 Amps: 9.4
 Watts: 2055 Outlet: 3" FIPT
 Weight: 95 lbs.
 Dimensions: 15"L x 8 1/2"W x 23"H

Model: **A-05L** Motor: 1/2 HP
 Volts: 115 Amps: 6.6
 Watts: 725 Outlet: 2" FIPT
 Weight: 40 lbs.
 Dimensions: 10"L x 7"W x 17"H

Model #	Watts	Max	5'	10'	15'	20'	25'	30'	35'	40'	45'	50'	55'	60'
A-05	645	--	3165	2840	2500	2155	1875	1455	935	320				
A-05L	725	--	5040	4320	3600	2820	1920	840						
A-21	1060	--	5810	5325	4824	4335	3770	3140	2400	1530	540			
A-31	1160	--	9300	8150	6830	5535	4120	2535	625					
A-32	2055	--	12000	11040	10440	9780	9000	8280	7560	6780	5580	4920	3890	

*Operating pumps outside of the recommended range may cause bearing damage and premature failure.

Recommended Operating Range Best Efficiency Point Do Not Operate Range

Model: **A-21** Motor: 1 HP
 Volts: 115 Amps: 10
 Watts: 1060 Outlet: 2" FIPT
 Weight: 43 lbs.
 Dimensions: 10"L x 7"W x 17"H

PUMP PROTECTOR

The easiest way to damage a pump is to run it while it is not fully submerged in water. Water levels can be difficult to monitor, especially when the pump is hidden away inside a pump vault or skimmer box, where clogged filtration can restrict water flow, leading to low water levels or even causing the pump to run dry. Enter Atlantic's Tidal Wave Pump Protector, which will automatically shut off a pump before it can be damaged. Unlike water level sensors and built-in thermal protectors, which can cycle on and off repeatedly, ultimately allowing pump failure, the TidalWave Pump Protector electronically monitors subtle line power changes that are created by the pump during adverse load conditions. When the current change exceeds a pre-set internal threshold, power to the pump is cut off until physically reset. There is no cycling on and off like with float sensors that reset themselves. The TidalWave Pump Protector installs easily and calibrates to all direct drive pumps.



MODEL:

Model: **TWPP14**
 Input Voltage: 120 VAC
 Max Amps: 14
 For Use With: Direct Drive pumps
 Warranty: 1 year

Protects Against:

- Operating Dry
- Current Spikes
- Current Drop
- Thermal Cycling
- Low Water Flow

INSTALLATION

Designed with you in mind to make installation and adjustment easier, Atlantic has everything you need for your water features. Featuring products like 45mil EPDM liner, FallsFoam, flexible PVC pipe, RTV silicone, AF1000 Auto Fill and Sch 40 fittings that are proudly manufactured in the USA to the highest standards, Atlantic installation accessories stand the test of time and keep your water feature running for years.

TRITON CHECK VALVE



Triton Check Valve with Pumps:



TW3700 uses 1 1/2" Discharge

PAF-25 uses 2" Discharge



Atlantic's award winning Triton Check Valve is the only check valve designed exclusively for the water garden industry. The 'swing style' Triton Check Valve features a 2" socket union on the inlet, 2" and 1 1/2" socket unions for the outlet, a molded-in 90° elbow, and a slim design that allows clearance when installed with direct drive pumps. If simplicity and innovation are what you seek, Triton delivers!

Model: TR215CV

Valve Dimensions:

5 7/8" L x 3 1/2" W x 10" H

Inlet: 2" socket

Outlet: 1 1/2" or 2" Sch 40 socket

Pipe Dimension: 11 7/8" L x 2 5/8" W

Inlet: 1 1/2" or 2" MIPT

Outlet: 2" Sch 40 pipe

Includes: 2" check valve with unions, 1 1/2" outlet fitting, and discharge pipe



Triton Discharge Pipe with "perfect-cut" dimensions for Atlantic products. (Cut-to-fit 1" increments on reverse side.)



NOTE the Triton Check Valve will work with all 1 1/2" & 2" discharge TidalWave pumps, and all Atlantic equipment. The discharge pipe must be extended using 2" PVC pipe and a slip x slip coupling when installed within the PV2300, PS15000 or if Pump Vault extensions are used.

TRITON CHECK VALVE FEATURES:

- Molded "perfect-cut" dimensions to identify proper lengths for Atlantic products and cut-to-fit 1" increments on the reverse side
- Works with all 1 1/2" and 2" pump outlets
- Maximum assembled height of 17" (from the pump discharge to the center of the outlet pipe)
- Can be extended to any length using 2" Sch 40 fittings

3" CHECK VALVE



Atlantic's AWGCV30 features a full flow 3" 'swing style' check valve with an offset valve body, 90° elbow and a 3" rubber coupling on the outlet. A 3" pump discharge pipe (not included) can be extended to any length using 3" PVC.

Model: AWGCV30

Valve Dimensions: 11 1/2" L x 5 1/2" W x 13 1/2" H

Inlet: 3" socket

Outlet: 3" rubber coupling

Check Valve with TidalWave A-Series Pump:



3" Check Valve attached to A-31 pump

INSTALLATION ACCESSORIES



FALLSFOAM

FallsFoam is an expandable foam sealant used to stabilize stones, fill voids and seal joints during waterfall construction. 12oz. DIY FallsFoam is perfect for homeowner projects, while 29oz. FallsFoam cartridges and foam guns are indispensable tools for professionals.

MODELS :

Model: LF1000
Description: 12 oz. can DIY Black Waterfall Foam with applicator straw

Model: LF1300
Description: 29 oz. can Professional Black Waterfall Foam

Model: LF1310
Description: Professional Foam Gun (alloy, for use with 29 oz. cans)

Model: LF1315
Description: Professional Foam Gun (composite, for use with 29 oz. cans)



Model: LF1325
Description: 12 oz. can Foam Gun Cleaner

RTV SILICONE SEALANT

Black RTV silicone sealant is used to create a watertight seal where liner is attached to filtration components. Permanently flexible RTV silicone used in conjunction with Atlantic's molded inserts, liner retention flanges and stainless steel hardware ensures a watertight connection every time.

MODELS :

Model: SN2800
Description: 2.8 oz. tube black RTV Silicone

Model: SN10300
Description: 10.3 oz. cartridge black RTV Silicone



AUTO FILL

Maintain a consistent water level in all Atlantic Skimmers, Pump Vaults, Colorfalls and Fountain Basins by installing an Auto Fill valve. Atlantic's AF1000 Auto Fill kits include fittings to connect to a water supply using standard garden hose, 1/2" irrigation line and 1/2" Sch 40 PVC.

MODEL :

Model: AF1000
Description: 1/2" MIPT Auto Fill valve



Atlantic also offers a full array of liner rolls and heavy duty pond underlayment, in full rolls and pre-cut sizes. Please contact Atlantic for details about all our installation accessories.

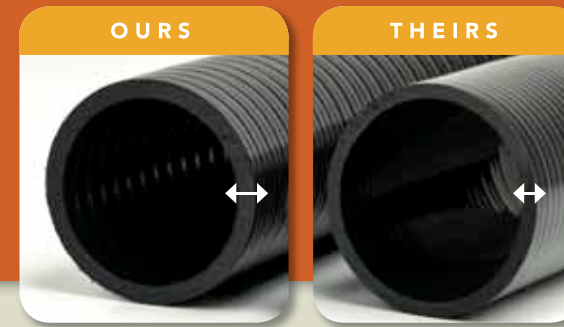

FLEXIBLE PVC PIPING

Think all flexible PVC pipe is the same? Take a closer look... Atlantic's top quality, American made Schedule 40 PVC piping is heavy walled, extremely flexible and incredibly durable. Decrease labor, maximize pump flow and eliminate call-backs with flexible PVC piping from Atlantic.

MODELS :

Model: FH1525
Description: 1 1/2" x 25' PVC Black Flex Pipe

Model: FH1550
Description: 1 1/2" x 50' PVC Black Flex Pipe

Model: FH225
Description: 2" x 25' PVC Black Flex Pipe

Model: FH250
Description: 2" x 50' PVC Black Flex Pipe

Model: FH350
Description: 3" x 50' PVC Black Flex Pipe



FITTINGS

MODELS :

Model: HA1550
Description: Bulkhead 1 1/2" FIPT

Model: HA2000
Description: Bulkhead 2" FIPT

Model: HA3000
Description: Bulkhead 3" FIPT

Model: 436-015
Description: 1 1/2" Male Thread Adaptor (MIPT x Slip)

Model: 436-020
Description: 2" Male Thread Adaptor (MIPT x Slip)

Model: 436-030
Description: 3" Male Thread Adaptor (MIPT x Slip)

Model: 429-015
Description: 1 1/2" Coupler (Slip x Slip)

Model: 406-015
Description: 1 1/2" 90° (Slip x Slip)

Model: 429-020
Description: 2" Coupler (Slip x Slip)

Model: 406-020
Description: 2" 90° (Slip x Slip)

Model: 429-030
Description: 3" Coupler (Slip x Slip)

Model: 406-030
Description: 3" 90° (Slip x Slip)



LIGHTING

Enjoy your water features deep into the night with Atlantic's LED lighting systems. Featuring brass-bodied SOL Lights, in both Warm White and Color Changing varieties, Atlantic's low energy consumption LEDs give your space a welcome warming glow, above ground or under water, all night long. Atlantic SOL lighting is long-lasting, energy-efficient and carries a one-year warranty.



Featuring built-in photo cells that automatically turn lights on at dusk and off at dawn, Atlantic's AWG line of LED lights eliminate the need for timers and switches. AWG LED lights can be used both underwater and in open air applications, and are available in large, small and fountain light sizes.

MODELS :



Model: AWGLED1
Description: Single Warm White Pond Light w/quick connect plug
Voltage: 12 volt AC
Watts: 1.6
Includes: Light base, photo cell, ground stake, outdoor transformer & 22' power cord



Model: AWGLED3
Description: 3 Pack Warm White Pond Light w/quick connect plug
Voltage: 12 volt AC
Watts: 4.8
Includes: Light bases (3), photo cell, ground stake, transformer and 22' power cord - 3½' cord between lights



Model: AWGLEDLG
Description: Large Single Warm White Pond Light w/quick connect plug
Voltage: 12 volt AC
Watts: 4.8
Includes: Light base, photo cell, ground stake, transformer and 22' power cord

The newest addition to the AWG LED line, our Fountain Light with 8 Warm White LEDs fits perfectly in the top of our Pebble Pots and Basalt Columns for a delightful 'liquid torch' effect that extends their appeal deep into the night. With an adjustable nipple to vary the height of the illuminated plume, these long-lasting accents are economical and easy to install.



Model: AWGFT2
Description: Warm White Fountain Light
Voltage: 12 volt AC
Watts: 1.5
Includes: LED fountain light, ½" MPT x ¾" insert fitting, outdoor transformer & 20' power cord

LED LIGHTING

Atlantic's SOL Lighting features solid brass bodies with an oil rubbed bronze finish that adds class to your application while reducing the heat emitted. Available in both 2 watt and 6 watt warm white bullet styles and in a Light Ring perfect for fountains and waterfalls, these lights are a great way to enjoy your water feature after the sun goes down.

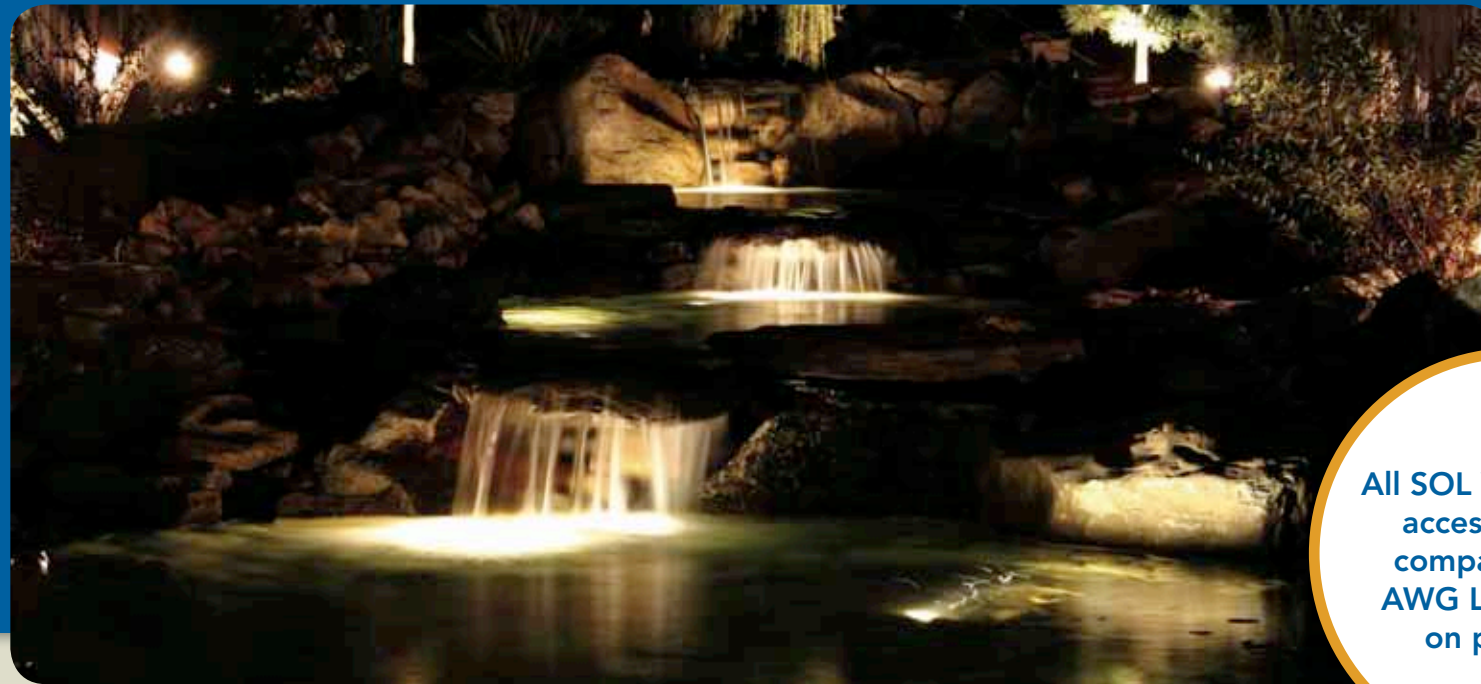

All SOL Warm White accessories are compatible with AWG LED's found on page 55.

MODELS :



Model: SOLW2
Description: Compact Warm White Spotlight
Input Voltage: 12 volt AC
Watts: 2
Beam Angle: 45 Degrees
Dimensions: 2½"L x 1⅛"W
Includes: LED Spotlight, 20' power cord w/ quick-connect plug, stand and ground stake



Model: SOLW6
Description: Warm White Spotlight
Input Voltage: 12 volt AC
Watts: 6
Beam Angle: 45 Degrees
Dimensions: 3¼"L x 2"W
Includes: LED Spotlight, 20' power cord w/ quick-connect plug, stand and ground stake



Model: SOLWLR
Description: Warm White Light Ring
Input Voltage: 12 volt AC
Watts: 7
Beam Angle: 150 Degrees
Dimensions: 3½"OD x 1⅜"ID x ¾"H
Includes: LED Light Ring, 20' power cord w/ quick-connect plug



Model: SOLW2X4
Description: 4 pack / Compact Spotlights
Input Voltage: 12 volt AC
Watts: 8
Beam Angle: 45 Degrees
Includes: (4) SOLW2 Compact Spotlights, transformer and 4-way splitter



Model: SOL20X4
Description: Transformer and 4-way Splitter
For Use With: Warm White AWG and SOL Lighting
Voltage: 12 volt AC / 2-wire
Watts: 20
Includes: Transformer and 4-way splitter w/ quick-connect plugs



Model: SOLWEXT
Description: 20' 2-wire Extension Cord
For Use With: Warm White AWG and SOL Lighting



Model: SOLWSPL4
Description: 4-way splitter / 2-wire
For Use With: Warm White AWG and SOL Lighting
Voltage: 12 volt
Includes: Weather-proof caps



Model: SOLTRANS88
Description: 88 Watt Transformer
Input Voltage: 120 volt AC
Output Voltage: 12 volt AC / 88 watts
Dimensions: 4" L x 4" W x 7" H



Model: SOLW88X10
Description: 10 Light Wiring Kit and Transformer
For Use With: Warm White AWG and SOL Lighting
Input Voltage: 120 volt AC
Output Voltage: 12 volt AC / 88 watts
Includes: 88 watt transformer, (3) 3-way splitters, (2) 20' extension cords

COLOR CHANGING

For those looking to bring more than just a warming glow to your evening, Atlantic's Color Changing SOL LEDs are the solution. Just like our popular Color Changing Colorfalls, these LEDs create a vibrant nighttime atmosphere with 48 different colors and 16 different color changing combinations. Multiple LEDs can be connected to be run through one transformer and be controlled together, all by remote!

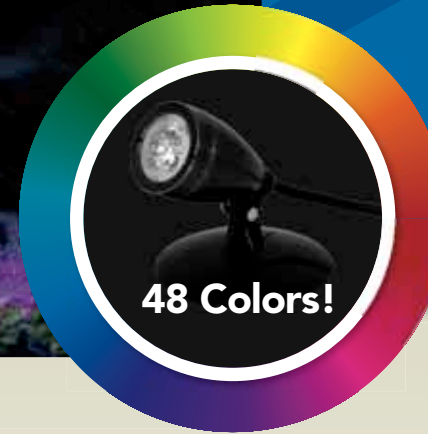

MODELS :



Model: SOLCC2
Description: Compact Color Changing Spotlight
Input Voltage: 12 volt DC
Beam Angle: 45 Degrees
Dimensions: 2 1/2" L x 1 1/8" W
Watts: 1 - 2.5 variable
Includes: Color Changing LED Spotlight, 20' power cord w/ quick-connect plug, stand and ground stake



Model: SOLCC6
Description: Color Changing Spotlight
Input Voltage: 12 volt DC
Beam Angle: 45 Degrees
Dimensions: 3 1/4" L x 2" W
Watts: 3 - 6 variable
Includes: Color Changing LED Spotlight, 20' power cord w/ quick-connect plug, stand and ground stake



Model: SOLCCLR
Description: Color Changing Light Ring
Input Voltage: 12 volt DC
Beam Angle: 150 Degrees
Dimensions: 3 1/2" OD x 1 3/8" ID x 3/4" H
Watts: 2 - 6 variable
Includes: Color Changing LED Light Ring, 20' power cord w/ quick-connect plug

NEW



Model: SOLCC2X3
Description: 3 pack / CC Compact Spotlights
Input Voltage: 12 volt AC
Watts: 3 - 7.5 variable
Beam Angle: 45 Degrees
Dimensions: (3) 2 1/2" L x 1 1/8" W
Includes: (3) SOLCC2 Compact Spotlights, transformer, 3-way splitter, control module and remote control



Model: SOLCCMX3
Description: SOL Color Changing Control Module
For Use With: Color Changing SOL Lighting
Input Voltage: 12 volt AC
Output Voltage: 12 volt DC / 6-wire
Includes: 24 watt transformer, 3-way splitter, control module and remote control



Model: SOLCCEXT
Description: 20' 6-wire Extension Cord
For Use With: Color Changing SOL Lighting

NEW



Model: SOLCCSPL3
Description: 3-way splitter / 6-wire
For Use With: Color Changing SOL Lighting
Voltage: 12 volt
Includes: Weather-proof plugs

NEW



Model: SOLCCMX7
Description: 7 Light Wiring Kit and Transformer
For Use With: Color Changing SOL Lighting
Voltage: 12 volt
Includes: 88 watt transformer, (3) 3-way splitters, (2) 20' extension cords

NOT COMPATIBLE WITH COLOR CHANGING COLORFALLS

MAINTENANCE

Installing a beautiful water garden is only the beginning. Atlantic offers a full line of maintenance products that will keep your water feature healthy and beautiful for years to come. Our Biocuda treatments keep your pond crystal clear, while seasonal products like our Pond & Garden Protectors protect your water feature when the weather is less favorable. Whatever your maintenance needs, Atlantic has you covered!

Triton IONIZER

The Triton Ionizer's modular design is at the cutting edge of innovation, featuring tool-less, seamless integration with our award-winning Triton Check Valve! Safe for animals and plants and unaffected by sunlight and heat, this mineralized water maintains a residual ability to treat organics, greatly reducing the need for chemical treatments.



TRION2 Ionizer, TR215CV Check Valve and PS3900 shown

TRITON IONIZER FEATURES:

- Safe for fish and plants
- Low maintenance
- Clears water without the use of harsh chemicals
- Level of mineralization is controlled by the LED panel
- Treats ponds up to 25,000 gallons
- Easily installed in any new or existing water feature
- Electrodes are easily replaced without tools
- 1-year warranty



Model: **TRION2**
 Description: Electronic Water Clarifier
 Application: Pond / Pond-free / Fountain
 Input Voltage: 12 volt AC
 Watts: 2
 Inlet/Outlet: 2" Sch 40 PVC
 Includes: Outdoor transformer and copper test strips



Alkalinity / pH / Copper Test Strips

Part No: **TRION-TS**



Triton Ionizer Replacement Anode

Part No: **TRION2-RA**

HOW IT WORKS:

The Triton Ionizer utilizes the same union fittings and adapters as the Triton Check Valve, so connecting the Ionizer above or below the Check Valve takes only seconds. Periodic replacement of electrodes is just as simple. Instead of the whole assembly, only the electrodes are changed, again without needing tools. It doesn't get any simpler or better designed than this!



WATER TREATMENTS



CLARITY-BLAST+ THE ULTIMATE POND CLEANER

Clarity Blast+ breaks down organic debris with a powerful combination of bacteria, enzymes and a proprietary secret ingredient to clean waterfalls, streams, plant pots and filtration systems. With a patented process that combines bacterial cultures with natural extracts, Clarity Blast+ with Activated Barley helps to remove and control the pond hobbyist's worst long term pond problem.

Part #	Size	Gal. Treated
5CB3/4	¾ lbs.	6,000 gal
5CB21/2	2½ lbs.	20,000 gal
5CB7	7 lbs.	56,000 gal

- Removes Pond Owner's Worst Problem
- Removes Slimy Debris From Ponds, Waterfalls and Streams
- Safe for Aquatic and Domestic Animals



BIO-MAX BENEFICIAL BACTERIA

To remove sludge, leaves, debris and odors, Bio-Max dry formula contains several billion bacteria per gram and 6 added enzymes. Potent bacterial strains, grown on Activated Barley in a patented process, clean and clear ponds, improve dissolved oxygen and lower nitrate levels that might otherwise feed rampant algae growth.

Use along with Bio-Max+ in a weekly maintenance program to keep sludge at bay and water quality at its peak.

Part #	Size	Gal. Treated
5BM1/3	⅓ lbs.	5,300 gal
5BM1	1 lbs.	16,000 gal
5BM6	6 lbs.	96,000 gal

- Removes Sludge and Odor Fast
- Breaks Down Dead Algae, Leaves and Debris
- Safe for Aquatic and Domestic Animals



BIO-MAX+ ALL SEASON BENEFICIAL BACTERIA

Bio-Max+ All Season liquid formulation removes ammonia and nitrites, as well as nitrates and organic debris, year 'round, in any water feature.

The concentrated denitrifying bacteria and powerful enzymes in Bio-Max+ All Season Beneficial Bacteria rank it among the strongest on the market today.

- Clears Water, Removes Debris and Seeds Filters
- Keeps Your Water Clear Year Round
- Safe for Aquatic and Domestic Animals

Part #	Size	Gal. Treated
5BM+16	16 oz.	48,000 gal
5BM+32	32 oz.	96,000 gal
5BM+64	64 oz.	192,000 gal
5BM+1G	1 gal	384,000 gal



RE-VIVE DECHLORINATOR LIQUID

Re-Vive quickly removes chlorine, chloramines and heavy metals often present in municipal water supplies, while enhancing the protective slime coat that helps fish recover from wounds and abrasions. Re-Vive is especially beneficial in times of stress, protecting fish during top-offs, water changes and pond cleanouts.

Part #	Size	Gal. Treated
5RV16	16 oz.	3,200 gal
5RV32	32 oz.	6,400 gal

- Immediately Removes Chlorine, Chloramine & Heavy Metals
- Adds Fish Slime Coat Protectant
- Safe for Aquatic & Domestic Animals



QUICK-CLEAR POND FLOCCULENT

Quick-Clear rapidly restores brilliant clarity to cloudy or dirty pond water by causing suspended particles in the water to clump, or flocculate. The heavier clumps drop out of suspension to the bottom where they are easily filtered or vacuumed out, clearing the pond quickly and effectively.

Part #	Size	Gal. Treated
5QC16	16 oz.	8,000 gal
5QC32	32 oz.	16,000 gal

- Clears Pond Water Fast
- Makes Pond Water Sparkle
- Safe for Aquatic and Domestic Animals



ECO-SOLV9 COMPLETE POND CLEANER

Eco-Solv9 is the fastest water clarifier on the market for all water features – pond, pond-free, fountain or bubbler. A full 9% of active ingredient, double that of competing brands, clears pond water regardless of color, gives better results and lasts far longer.

- Clears Water, regardless of color
- Removes attached and suspended organic debris
- 2X more concentrated

Part #	Size	Gal. Treated
5ES16	16 oz.	9,600 gal
5ES32	32 oz.	19,200 gal
5ES64	64 oz.	38,400 gal
5ES1G	1 gal	76,800 gal



ECO-KLEAN OXY POND CLEANER

Eco-Klean quickly and safely removes attached organics from rocks, waterfalls, streambeds and anywhere else build-up occurs. Fast dissolving granules add oxygen to the pond, remove odors and, when used regularly, can actually eliminate the need for disruptive, expensive complete pond cleanouts.

- Immediately removes organic debris
- Deep cleans rocks, waterfalls, and streambeds
- Safe for Aquatic & Domestic Animals

Part #	Size	Gal. Treated
5EK3/4	¾ lbs.	7,500 gal
5EK21/2	2½ lbs.	25,000 gal
5EK10	10 lbs.	100,000 gal



FISH FOOD



MODELS :

SUMMER FISH FOOD

Biocuda Summer Food is formulated for warm weather feeding to produce maximum fish growth and color enhancement. The result of years of laboratory and extensive field research and development with top breeders, Biocuda Summer Food offers a premium blend of vitamins and minerals specifically designed to aid in color, growth and vitality of your fish.

Water Temperatures 65°F and above

- Nitrogen flushed for maximum freshness
- Never clouds water
- Contains natural pigments for maximum color enhancement

Part #	Size
BCS050	½ lb.
BCS125	1¼ lbs.
BCS500	5 lbs.



COLD WATER FISH FOOD

Biocuda Cold Water Food is designed for cool weather feeding and color enhancement of your fish. It is formulated for high palatability and digestibility to minimize excreted waste. Biocuda Cold Water Food contains stable Vitamin C and Brewer's Yeast to promote fin, gill and tissue development, while nutrient supplements aid in overall fish health and resistance to disease.

Water Temperatures 55°F to 65°F

- Contains wheat germ to aid in digestion
- Never clouds water
- New supplements to improve overall health and disease resistance

Part #	Size
BCC050	½ lb.
BCC125	1¼ lbs.
BCC500	5 lbs.



Atlantic's Typhoon Air Pumps feature indoor/outdoor, continuous duty diaphragm compressors specifically designed for year-round usage. Ideal for aeration and circulation in warm weather, these aerators are especially dependable for de-icing and gas exchange in freezing weather, unlike floating de-icers that often fail under harsh conditions. Best of all, energy-efficient Typhoon Air Pumps draw only a tiny fraction of the power, and can easily be rebuilt for exceptionally long life!

MODELS :



Model: TA1800
Description: Diaphragm Air Pump
Outlet : 3/8" insert, 1/2" slip
Volts: 115
Watts: 25
Max Pressure: 3 psi
Max Depth: 7 Feet
Cord Length: 6'



Model: TA3600
Description: Diaphragm Air Pump
Outlet : 3/8" insert, 5/8" slip
Volts: 115
Watts: 35
Max Pressure: 5 psi
Max Depth: 11 Feet
Cord Length: 6'

Model #	Output (LPM)					
	Max	@2'	@4'	@6'	@8'	@10'
TA1800	30	21	13	4		
TA3600	60	47	34	23	12	3

TYPHOON AIR PUMP FEATURES:

- Weather-proof aluminum housing
- Noise dampening design
- Energy efficient & low maintenance
- 1-year warranty



Shallow aeration keeps ice from forming all winter long.

TYPHOON AERATION KITS

Year-round pond aeration has never been easier, with Atlantic's Typhoon Aeration Kits. These Kits provide complete solutions to your pond's aeration needs, winter and summer, at far lower cost than any water pump system. The secret is in the millions of tiny bubbles, which together lift and carry a tremendous quantity of water as they rise, effectively moving 10 times more volume per Watt than water pumps can. Whether you need deep warm weather circulation to keep temperatures and oxygen levels constant, or shallow water de-icing to keep a hole clear of ice in winter, these Kits come with everything you need, including premium airline tubing, long-lasting airstones, inline check valves and solid brass fittings.



Model: TAKIT1800
Description: TA1800 Aeration Kit
Includes: TA1800, 25' air line, in-line check valve and 6" airstone



Model: TAKIT3600
Description: TA3600 Aeration Kit
Includes: TA3600, 35' air line, in-line check valve, 2-way splitter, and (2) 6" airstones

POND & GARDEN PROTECTOR

Want a healthy pond first thing in the Spring? Protecting your pond in the fall is the best way to get a head start. To ensure a healthy winter environment for fish and to reduce spring maintenance, simply keep leaves and windblown debris from entering the pond in the fall. When a traditional pond net becomes laden with leaves that lay on or under the water surface, the leaves begin to decompose, affecting water quality and adding unwanted nutrients to the ecosystem. The domed design of Atlantic's Pond & Garden Protectors causes leaves to roll off the net where they can be collected easily. Easy to assemble and remove, the Pond & Garden Protector is the best and easiest way to start the new year off with a clean, healthy pond.

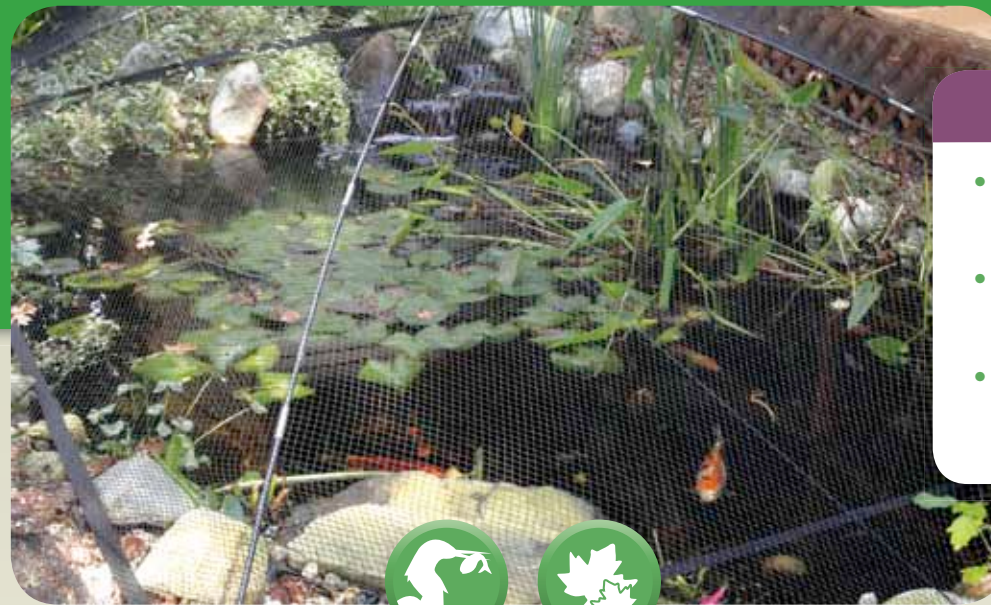

POND FEATURES:

- Keeps out leaves and other windblown debris
- Protects fish from heron and other predators
- Helps prevent algae growth by reducing organic waste



GARDEN FEATURES:

- Protects fruiting plants and vegetables
- Allows for sunlight and optimum plant ventilation
- Can be covered with plastic to protect against frost



Kit No.	Size	Net
PGPSM	7' x 9'	15' x 20'
PGPLG	9' x 12'	20' x 20'

Includes:

- Ultra Pond Net
- Nylon Base
- Center Receptor
- (4) Fiberglass Poles
- (4) 12' Tie-downs
- (4) Ground Stakes
- (12) Net Stakes
- (8) Net Clips



POND NETS

ULTRA POND NETS

Constructed of heavy-duty UV-resistant polypropylene, Ultra Pond Nets will last for years. The 1/2" x 1/2" opening keeps debris out while allowing sunlight and fresh air to enter. Includes 12 plastic stakes.

MODELS:

Part No: **PN1015**

Size: 10' x 15'

Part No: **PN2020**

Size: 20' x 20'

Part No: **PN1520**

Size: 15' x 20'

Part No: **PN2030**

Size: 20' x 30'



Ultra Pond Nets Include:

- Heavy-duty pond netting
- 1/2" x 1/2" hole size
- UV-resistant
- Each net is packed with 12 net stakes



RAIN HARVESTING

Whether using a small rain barrel or a large in-ground reservoir, Atlantic's innovative Rain Harvesting components are right for your project. With products like our Clean Rain Ultra Downspout Diverter, Eco-Blox and specially designed Rain Harvesting Pump Vault, we have everything you need to capture, store and re-use rain and storm water, allowing you to help the planet by reducing runoff while saving money on your water bill. Above ground, under pavers or below a waterfall, we have your Rain Harvesting solution.

Rain Harvesting™ CLEAN RAIN ULTRA DOWNSPOUT DIVERTER



Atlantic's all-in-one rainwater filtration and collection system collects, cleans and filters rainwater and accomodates multiple connection methods for immediate or future use in the garden and around the yard. User-friendly construction makes the Downspout Diverter a breeze to install and just as easy to use, the perfect 'green' product for anyone looking to conserve and re-use rainwater.

CLEAN RAIN FEATURES:

- Collects water from downspouts
- Leaf Eater rain head deflects leaves and debris
- Downspout Diverter automatically flushes away contaminants in the initial surge of runoff
- Includes stainless steel mosquito-proof screen
- Easy to install
- Can be mounted at any height for easy maintenance
- Works automatically once installed
- Can be switched off in winter months
- Connects to majority of hose sizes



Model: RHCRU
Dimensions: 8¼" L x 9" W x 31" H
Inlet/Outlet: 2" x 3" and 3" x 4" downspout - 3" and 4" Sch 40
Diverter Outlet: Garden hose, flex pipe and 3" Sch 40



Hydro Activated Filtration™ technology uses the rainwater's force to deflect leaves and debris off the screen.



The cover and cap provide a stylish, integrated finish and in colder climates, avert snow.

An easily accessible on/off switch to direct your rainwater for collection or return to normal downspout functioning.

Specially designed overflow mechanism ensures excess water safely overflows down your downspout.

Smart Sense™ First Flush functionality ensures that the majority of contaminants from the roof are flushed down the downspout.



Smart Sense's self regulating valve automatically adjusts to divert the optimum amount of dirty rainwater based on the intensity of the rainfall event.

Automatically works for every rainfall event.

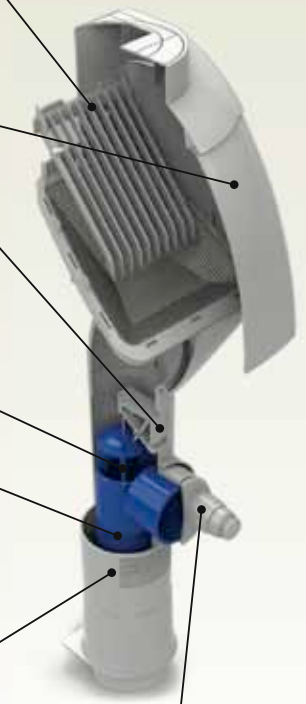

The hose outlet fits standard garden, pool and sump hoses and the cap removes to fit 3" Schedule 40 pipe.

Downspout Adaptors Included

Fits 2" x 3", 3" x 4" and 3", 4" downspouts



Compatible Hoses

Also fits 3" Schedule 40 pipe

Garden Hose



Standard

Sump Hose

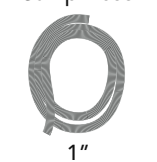

1"

Pool Hose



1½"

POND-FREE INSTALLATION

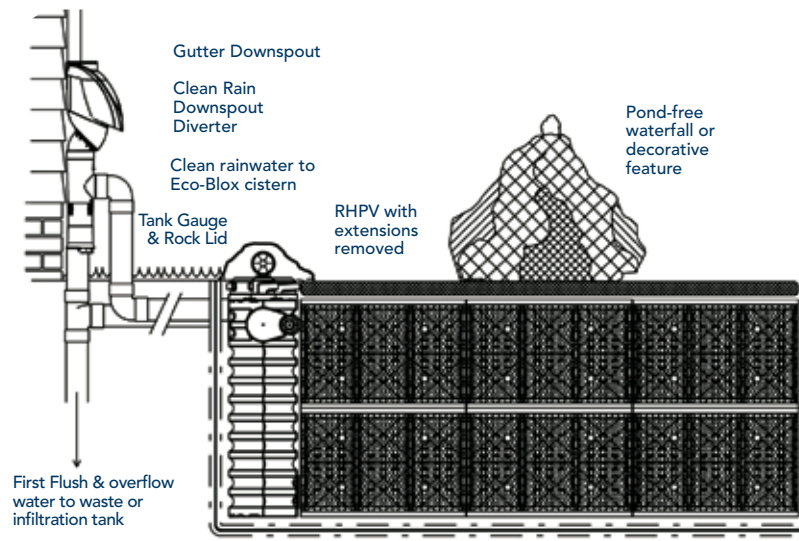

Atlantic's innovative Rain Harvesting components give you the ability to choose the best way to collect clean rainwater for future use. Using a combination of our Clean Rain Ultra, Rain Harvesting Pump Vault and Eco-Blox, our versatile products allow you to collect rainwater in a traditional cistern, below permeable pavers or in pond-free applications to give you the best system to fit your needs.

MODEL:



Model: RHPV
Description: Pump Vault
Dimensions: 20"L x 11"W x 48"H
Inlet: (2) 3" FIPT openings
Opening: 9 1/2"
Outlet: 1" spinweld
Max Pump Flow:

- Inside the Liner: 7,500 gph
- External @ 10': 6,500 gph
- External @ 20': 5,000 gph
- External @ 30': 2,000 gph

PAVER STONE INSTALLATION

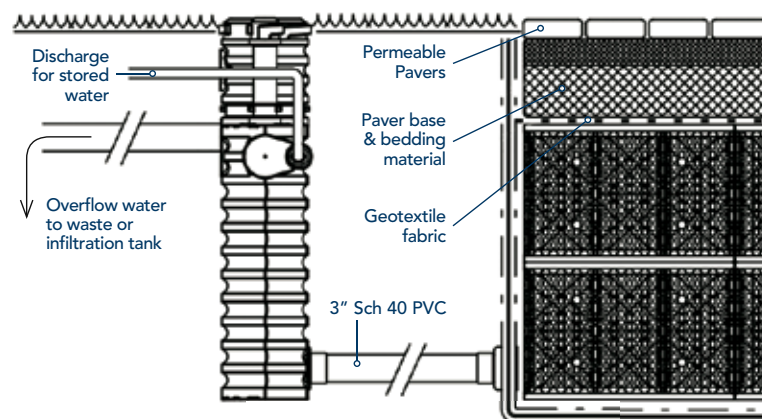

TYPICAL INSTALLATION

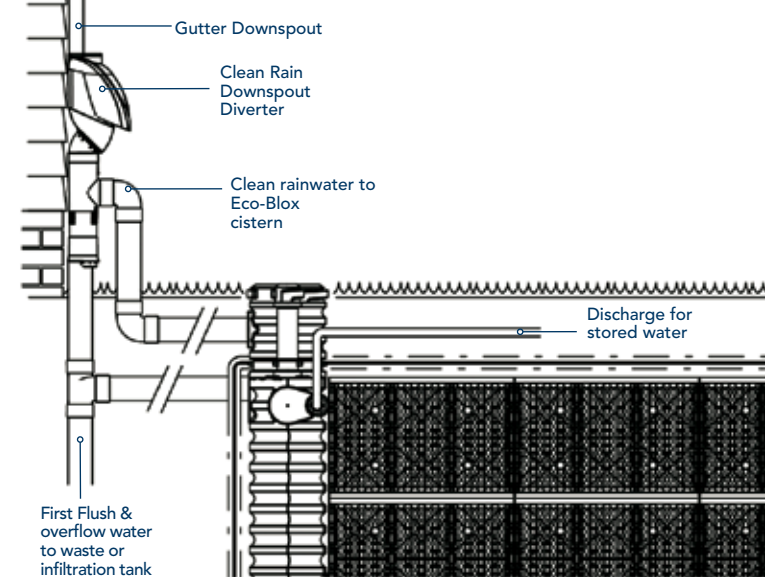

HOW IT WORKS:

Rainwater is collected from the gutter downspout and flows into the Clean Rain Ultra Downspout Diverter, which cleans waste, dirt and debris from the water. After the first flush of water is sent to waste, clean water then flows to the Eco-Blox reservoir to be stored for future use.

PUMP PERFORMANCE:

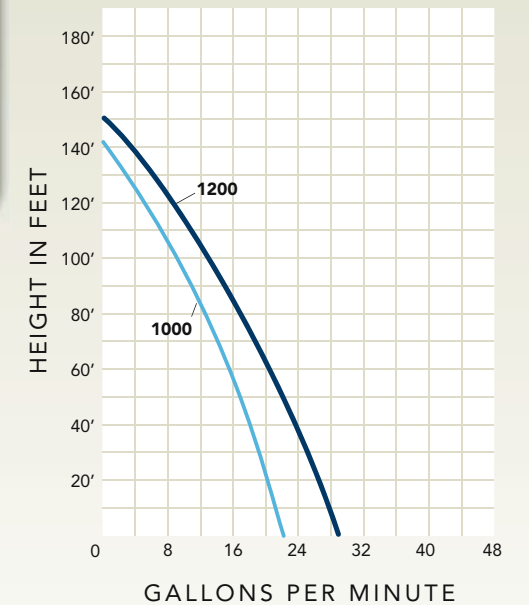

MODELS:



Model: RHEBS10
Description: External Pressure Pump
Dimensions: 18"L x 11"W x 13"H
Cord Length: 5'
Volts: 115 **Max Flow:** 22 gpm
Watts: 1000 **Max Pressure:** 64 psi

- Incredibly quiet, self-priming, water-cooled pump
- Built-in pressure switch & flow sensor
- Equipped with run-dry protection and internal check valve
- Automatically starts and stops when taps are opened
- Delivers constant pressure & flow rates



Model: RHDIV12
Description: Submersible Pressure Pump
Dimensions: 6"L x 6"W x 19"H
Cord Length: 48'
Volts: 115 **Max Flow:** 29 gpm
Watts: 1100 **Max Pressure:** 65 psi

- Extremely reliable and easy to install
- Built-in pressure switch & flow sensor
- Equipped with run-dry protection and internal check valve
- Automatically starts and stops when taps are opened
- Delivers constant pressure and flow rates

RAIN HARVESTING PUMP VAULT FEATURES:

1. Twist lock lids allow safe, easy access to the pump chamber and 3" tank gauge riser (gauge optional)
2. Comes with a 1" FIPT Spinweld® fitting for a pressure pump discharge and flat panels for additional plumbing
3. (2) 3" FIPT inlets allow installation inside the liner or out, via 3" lines and bulkhead fittings to remote Eco-Blox cistern
4. Risers allow for 13" of backfill and can be removed for pond-free installations
5. Equipped with flat panels for installing additional pump lines, downspout diverters and overflows



Clean Rain Ultra
 For features & specs See page 69.



Pro Series Eco-Blox
 For features & specs See page 32.

Rain Harvesting PRODUCTS

Atlantic's Rain Harvesting Accessories - providing you with everything you need for cleaning, storing and monitoring rainwater collection. Whether simply installing a rain barrel to your downspout or building a large scale Eco-Blox reservoir, we have what you need for rain harvesting on any scale, large or small.



Rain Harvesting KITS

Atlantic's Rain Harvesting Kits come complete, with everything you need to harvest and use rainwater. From the Clean Rain Ultra Downspout Diverter that collects and cleans rain from the roof, to the lined Eco-Blox basin that stores rainwater safe and algae-free underground, to the on-demand submersible or external pressure pump that activates at the turn of the tap, we've got you covered. Available in 504 and 1,008 gallon sizes, these Kits are a great way to "go green", conserve rainwater for future use, cut down on your water bill and, in some locales, even qualify for tax credits!

MODELS :

LEAF EATER

Attach a Leaf Eater to your downspout to ensure that no debris enters your basin. Easy to install, with a stainless steel mosquito-proof screen and pivoting outlet for either rear or bottom discharge, the Leaf Eater is both simple and effective.

Model: RHLE
Description: Leaf Eater
Dimensions: 7½"L x 6½"W x 9½"H
Outlet: 3" Sch 40



- Compact, versatile rain head is easy to install
- Prevents debris from entering the basin
- Outlet pivots for rear or bottom discharge
- Includes stainless steel mosquito-proof screen

TANK GAUGE

Atlantic's Tank Gauge allows you to easily monitor the water level in your basin, and installs easily into any Atlantic Pump Vault.

Model: RHTG
Description: Tank Gauge
Dimensions: 3¾"L x 2¾"W x 4½"H
Outlet: Requires 1¼" hole for installation



- Monitors water level of any storage system
- Quick and easy to install, suitable for all new and existing tanks
- Easy-to-read dial face with empty and full indicators
- Can be calibrated for holding systems up to 8' deep

COLLAPSIBLE RAIN BARREL

Our Rain Barrel connects easily to our Downspout Diverter and can be disassembled in minutes for easy storage when not in use. Garden hose fittings make it easy to deliver stored water wherever it's needed.

Model: RHCRB
Description: Collapsible Rain Barrel
Dimensions: 24"W x 36"H
Outlet: Spigot & garden hose

- Easy assembly connects to the downspout diverter
- Constructed of flexible wear resistant PVC with sturdy aluminum frame
- Collapsible and easy to store when not in use
- 60 gallon capacity



MODELS :



RainHarvesting Kit with RHDIV12 Submersible Pressure Pump:

- Clean Rain Ultra Downspout Diverter
- Rain Harvesting Pump Vault
- 45 mil EPDM pond liner
- Heavy-duty underlayment
- RHDIV12 Submersible Pressure Pump
- Tank Gauge
- Eco-Blox
- Fittings

Kit No.	Capacity	Liner Size	Underlayment	Eco-Blox
RHKIT500DIV	504 gal	15' x 20'	(2) 12' x 25'	16
RHKIT1000DIV	1,008 gal	20' x 25'	(4) 12' x 25'	32



RainHarvesting Kit with RHEBS10 External Pressure Pump:

- Clean Rain Ultra Downspout Diverter
- Rain Harvesting Pump Vault
- 45 mil EPDM pond liner
- Heavy-duty underlayment
- RHEBS10 External Pressure Pump
- Tank Gauge
- Eco-Blox
- Fittings

Kit No.	Capacity	Liner Size	Underlayment	Eco-Blox
RHKIT500EBS	504 gal	15' x 20'	(2) 12' x 25'	16
RHKIT1000EBS	1,008 gal	20' x 25'	(4) 12' x 25'	32



POP MATERIAL & TRAINING

Visit www.atlanticwatergardens.com for more details about Atlantic University. You can find the University in the "Tools" section.



COLLEGE OF CONSTRUCTION

Enroll today in the College of Construction to explore the Departments of Ponds, Pond-free and Decorative Features. Our free courses take you step-by-step through the basics of building water features - how to estimate materials, the types of equipment available, what common pitfalls to avoid. When you're finished, take a Final Exam to test your knowledge and we'll send out your Certificate of Completion in the mail.



COLLEGE OF FILTRATION

Visit the College of Filtration to explore the Departments of Prefiltration, Mechanical Filtration and Biological Filtration, the different types of equipment involved and the processes that govern the functioning of each type of filter. Continue on to more advanced seminars on the Ammonia Cycle, Water Quality, Passive and Active Bog Filtration before you sit for the on-line Final and receive your "degree", suitable for framing!

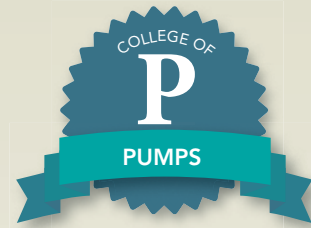

COLLEGE OF PUMPS

The College of Pumps starts with the different types of pumps for water features, how pumps work, how to choose the right pump for your project and how to plumb it properly. It then introduces more advanced topics like Total Dynamic Head, Friction and Flow and the Advantages of Redundancy, or how to use two pumps to cut operating costs. Don't forget to take your Final Exam to receive your Certificate of Completion, because you'll have earned it!



COLLEGE OF BIOLOGY

Visit the College of Biology to explore the worlds of the fish, fowl, flora and fauna that live in and around water features. From the microbes that make life possible to the algae that plague us, from the fish we delight in to the critters that eat them, you'll find an introduction to the whole cast of characters in the College of Biology. When you're done, test yourself to receive ultimate validation of your achievements!



Description: Colorfalls Tri-fold / Biocuda Treatment Guide
Dimensions: 3½"W x 8½"H (11"W x 8½"H open)



Description: Atlantic Wall Banner / Colorfalls Wall Banner
Dimensions: 60"W x 36"H



Description: Let's Talk Series - Ponds / Pond-free / Water features / Pumps
Dimensions: 8½"W x 11"H (25½"W x 8½"H open)



Description: Atlantic Planogram Header Card
Dimensions: 48"W x 18"H



Description: TidalWave Pump Counter Mat
Dimensions: 19"W x 14"H



Description: SOL Lighting Retractable Floor Banner
Dimensions: 33½"W x 78"H



Description: Color Changing Vase Retractable Floor Banner
Dimensions: 33½"W x 78"H



 **Atlantic**[™]
Discover the Difference

4494 Orchard St., Mantua, Ohio 44255 • Phone 330-274-8317 • Fax 330-274-8790
info@atlanticwatergardens.com • www.atlanticwatergardens.com

© 2014 Atlantic Water Gardens